



Printer/Scanner Unit Type 3045

Operating Instructions Scanner Reference



-
- 1** Getting Started
 - 2** Sending Scan Files by E-mail
 - 3** Sending Scan Files by Scan to Folder
 - 4** Storing Files
 - 5** Delivering Scan Files
 - 6** Using the Network TWAIN Scanner Function
 - 7** Configuring/Registering Scan Settings
 - 8** Troubleshooting
 - 9** Initial Scanner Setup
 - 10** Appendix

Read this manual carefully before you use this machine and keep it handy for future reference. For safe and correct use, be sure to read the Safety Information before using the machine.

Introduction

This manual contains detailed instructions and notes on the operation and use of this machine. For your safety and benefit, read this manual carefully before using the machine. Keep this manual in a handy place for quick reference.

Two kinds of size notation are employed in this manual. With this machine refer to the metric version.

Important

Contents of this manual are subject to change without prior notice. In no event will the company be liable for direct, indirect, special, incidental, or consequential damages as a result of handling or operating the machine.

Do not copy or print any item for which reproduction is prohibited by law.

Copying or printing the following items is generally prohibited by local law:

bank notes, revenue stamps, bonds, stock certificates, bank drafts, checks, passports, driver's licenses.

The preceding list is meant as a guide only and is not inclusive. We assume no responsibility for its completeness or accuracy. If you have any questions concerning the legality of copying or printing certain items, consult with your legal advisor.

Manuals for This Machine

The following manuals describe the operational procedures of this machine. For particular functions, see the relevant parts of the manual.

Note

- The manuals provided are specific to machine type.
- Adobe Acrobat Reader/Adobe Reader is necessary to view the manuals as a PDF file.
- Two CD-ROMs are provided:
 - CD-ROM 1 "Operating Instructions"
 - CD-ROM 2 "Scanner Driver and Document Management Utility"

❖ **General Settings Guide (PDF file - CD-ROM1)**

Provides an overview of the machine and describes System Settings (such as Tray Paper Settings), Document Server functions and troubleshooting. Refer to this manual for Address Book procedures such as registering fax numbers, e-mail addresses, and user codes.

❖ **Security Reference**

This manual is for administrators of this machine. It describes security functions that the administrators can use to protect data from being tampered, or prevent the machine from unauthorized use. Also refer to this manual for the procedures for registering administrators, as well as setting user and administrator authentication.

❖ **Network Guide (PDF file - CD-ROM1)**

Provides information about configuring and operating the printer in a network environment or using software. This manual covers all models, and therefore contains functions and settings that may not be available for your model. Images, illustrations, functions, and supported operating systems may differ from those of your model.

❖ **Copy Reference (PDF file - CD-ROM1)**

Describes operations, functions, and troubleshooting for the machine's copier function.

❖ **Facsimile Reference <Basic Features> (PDF file - CD-ROM1)**

Describes operations, functions, and troubleshooting for the machine's facsimile function.

❖ **Facsimile Reference <Advanced Features> (PDF file - CD-ROM1)**

Describes advanced facsimile functions such as line settings and procedures for registering IDs.

❖ **Printer Reference (PDF file - CD-ROM1)**

Describes system settings, operations, functions, and troubleshooting for the machine's printer function.

❖ **Scanner Reference (this manual) (PDF file - CD-ROM1)**

Describes operations, functions, and troubleshooting for the machine's scanner function.

❖ **Manuals for DeskTopBinder Lite**

DeskTopBinder Lite is a utility included on the CD-ROM labeled "Scanner Driver and Document Management Utility".

- DeskTopBinder Lite Setup Guide (PDF file - CD-ROM2)

Describes the installation of DeskTopBinder Lite, and the operating environment for DeskTopBinder Lite in detail. This guide can be displayed from the **[Setup]** dialog box when DeskTopBinder Lite is installed.

- DeskTopBinder Lite Introduction Guide (PDF file - CD-ROM2)

Describes operations with DeskTopBinder Lite and provides an overview of its functions. This guide is added to the **[Start]** menu when DeskTopBinder Lite is installed.

- Auto Document Link Guide (PDF file - CD-ROM2)

Describes operations and functions of Auto Document Link installed with DeskTopBinder Lite. This guide is added to the **[Start]** menu when DeskTopBinder Lite is installed.

❖ **Other manuals**

- PS3 Supplement (PDF file - CD-ROM1)

- UNIX Supplement (available from an authorized dealer, or as a PDF file on our Web site)

TABLE OF CONTENTS

Manuals for This Machine	i
How to Read This Manual	1
Symbols	1
Names of Major Options	1

1. Getting Started

Control Panel	3
Network Scanner	5
E-mail	5
Scan to Folder	6
Store.....	7
Network Delivery Scanner.....	8
Network TWAIN Scanner	9
Installing Software	10
Quick Install.....	10
TWAIN Driver	10
DeskTopBinder	11
User Authentication	12
User Code Authentication (Using the Control Panel)	12
Login (Using the Control Panel)	12
Log Off (Using the Control Panel)	13
Programming E-mail Addresses and Folders	14

2. Sending Scan Files by E-mail

Preparation for Sending by E-mail	15
E-mail Screen.....	16
Sending Scan Files by E-mail	17
Procedure for Sending E-mail	17
Simultaneous Storage and Sending by E-mail.....	27
Checking the E-mail Results	29

3. Sending Scan Files by Scan to Folder

Preparation for Sending by Scan to Folder	31
Scan to Folder Screen	32
Sending Scan Files by Scan to Folder	33
Procedure for Sending by Scan to Folder	33
Simultaneous Storage and Sending by Scan to Folder	43
Checking the Scan to Folder Results	45

4. Storing Files

Storing Files	47
Storage Procedure	48
Displaying the List of Stored Files	51
Viewing the List	52
Searching for Files	53
Sending Stored Files by E-mail or Scan to Folder, or Delivering	54
Checking Stored Files from a Client Computer	55
Managing Stored Files	57
Deleting Files	57
Changing File Information	57

5. Delivering Scan Files

Preparation for Delivering	62
Network Delivery Scanner Screen	63
Delivering Scan Files	64
Delivery Procedure.....	64
Simultaneous Storage and Delivery	69
Checking the Status of Delivery	71

6. Using the Network TWAIN Scanner Function

Preparation for Using the Network TWAIN Scanner	73
Scanning Originals	74

7. Configuring/Registering Scan Settings

Specifying Scan Settings	77
Making the Settings Related to the Orientation of the Original and Scanned Sides ...	79
For E-mail, Scan to Folder, and a Network Delivery Scanner.....	79
For a Network TWAIN Scanner.....	81
Scanning Originals in Several Times	82
When a Time Limit Is Specified for Additional Originals	82
When a Time Limit Is Not Specified for Additional Originals.....	84
Programs	85
Registering a Program	85
Recalling a Program.....	86
Changing a Registered Program.....	86
Deleting a Program	86
Changing the Program Name	87

8. Troubleshooting

If Your Machine Does Not Operate As You Want	89
When Scanning Is Not Performed as Expected	89
When Stored Files Cannot Be Accessed	89
Network Cannot Be Browsed When Sending a Scan File	90
The TWAIN Driver Cannot Be Started	90
Stored Files Cannot Be Edited.....	90
The Network Delivery Function Cannot Be Used.....	90
Operations are not possible when messages appear	91
When a Message Is Displayed	92
When an Error Message Appears on the Control Panel.....	92
When an Error Message Appears on the Client Computer.....	98

9. Initial Scanner Setup

Scanner Features	101
Adjusting Scanner Features	104
Settings	105
Scan Settings	105
Scanning a custom-size original	107
Destination List Settings.....	110
Send Settings.....	110
Administrator Tools	112

10. Appendix

Relationship between Resolution and File Size	113
When Using for E-mail, Scan to Folder, or Store, or as a Network Delivery Scanner ...	113
When Using as a Network TWAIN Scanner.....	114
Relationship between File Type Specified for Scanning and File Type Specified for E-mail/File	116
Placing Originals	117
Scanning Documents of Different Sizes	119
Software Supplied on CD-ROM	120
Table of files.....	120
TWAIN Driver	120
DeskTopBinder	121
Specifications for Transmission/Store/Delivery Functions	122
Transmission.....	122
Store.....	124
The network delivery scanner function.....	125
Specifications	126
INDEX	127

How to Read This Manual

Symbols

In this manual, the following symbols are used:

Important

If this instruction is not followed, paper might be misfed, originals might be damaged, or files might be lost. Be sure to read this.

Preparation

This symbol indicates the prior knowledge or preparations required before operating.

Note

This symbol indicates precautions for operation or actions to take after misoperation.

Limitation

This symbol indicates numerical limits, functions that cannot be used together, or conditions in which a particular function cannot be used.

Reference

This symbol indicates a reference.

[]

Keys that appear on the machine's display panel.

[]

Keys and buttons that appear on the computer's display.

[]

Keys built into the machine's control panel.

[]

Keys on the computer's keyboard.

Names of Major Options

Major options of this machine are referred to as follows in this manual:

- Printer/Scanner Unit Type 3045 → printer/scanner option
- File Format Converter Type B* → File Format Converter

The following software products are referred to using a general name:

- DeskTopBinder Lite and DeskTopBinder Professional* → DeskTopBinder
- ScanRouter EX Professional* and ScanRouter EX Enterprise* → the ScanRouter delivery software

* Optional

1. Getting Started

Control Panel

The illustration below details the control panel of a machine that has all options installed.

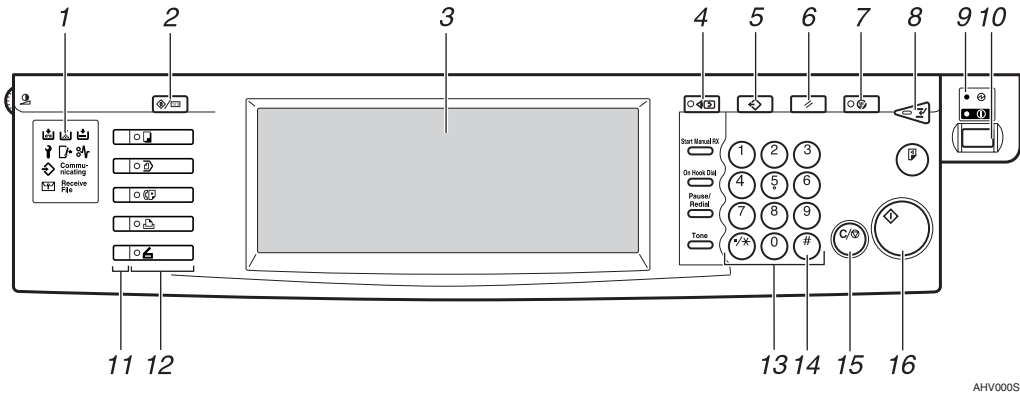

1. Indicators

Display errors and the machine status. See "Control Panel", *General Settings Guide*.

: Add Staple indicator

: Add Toner indicator

: Add Paper indicator

: Service Call indicator

: Open Cover indicator

: Misfeed indicator

2. [User Tools/Counter] key

Use to change default or operation parameters according to the operating conditions.

3. Display panel

Displays operation status, error messages, and function menus.

4. [Check Modes] key

Press to check the destinations which are currently selected.

5. [Program] key

Use to register settings used frequently as a program or to recall the registered program.

6. [Clear Modes] key

Press to clear the current settings.

7. [Energy Saver] key

Press this key to begin warm-up.

Pressing this key again while in warm-up mode cancels warm-up.

Note

This key is inactive while scanning or setting scanner defaults.

8. [Interrupt] key

Press this key to interrupt the scanner mode and to activate the copy mode.

9. Main power indicator and power indicator

The main power indicator lights up when the main power switch is set to on. The power indicator lights up when the machine is on.

Important

Do not turn off the main power while the power indicator is lit or blinking. Doing so may cause a failure of the hard disk.

10. Operation switch

Press this switch to turn the machine on. The power indicator lights up. To turn the machine off, press this switch again. See "Turning On the Power", *General Settings Guide*.

Note

- ❑ This key is inactive while scanning or setting scanner defaults.

11. Function status indicators

- When lit green, the corresponding function is active.
- When lit red, the corresponding function is interrupted. Press the respective key, and then follow the instructions that appear on the screen.

12. Function keys

Press the **[Copy]**, **[Document Server]**, **[Fax]**, **[Printer]**, or **[Scanner]** key to activate the respective function. The display content changes accordingly.

The indicator for the selected function lights up.

13. Number keys

Use to enter numeric values.

14. **[#]** key (Enter key)

Use to confirm the entered numeric value.

15. **[Clear/Stop]** key

- Clear: Clears an entered numeric value
- Stop: Stops scanning

16. **[Start]** key

Use to begin scanning, file storing, or delivery.

Network Scanner

By installing the printer/scanner option, the machine can be used as a network scanner. As a network scanner, the machine can send e-mail, send files to shared network folders, FTP server folders, or NetWare folders, store scan files, operate as a network delivery scanner, and operate as a network TWAIN scanner.

E-mail

A scan file that is attached to an e-mail can be sent using the e-mail system through a LAN or the Internet. Also, you can use this function together with the file storage function to e-mail URL addresses of files stored in the machine instead of sending the files as e-mail attachments.

Reference

p.15 "Sending Scan Files by E-mail"

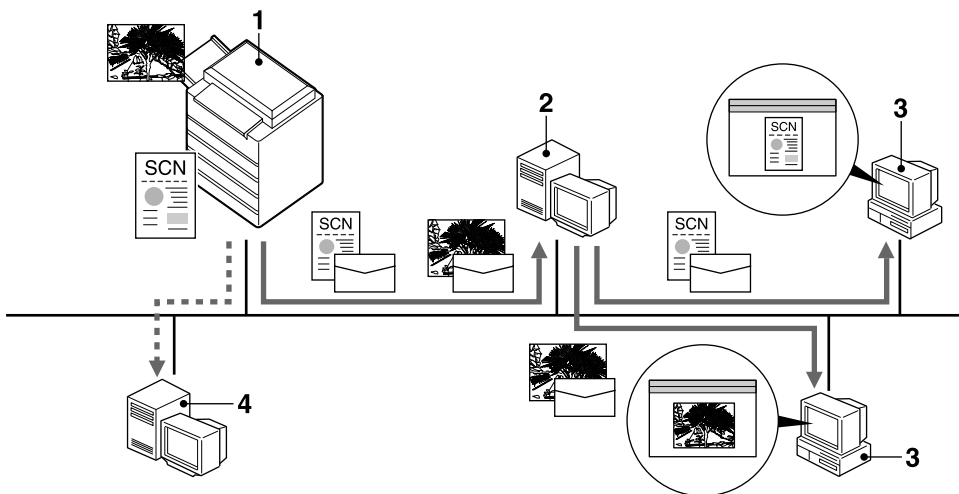

ZZ2601S

1. This machine

A scan file can be attached to an e-mail and sent to a mail server. In combination with the file storage function, scan files from multiple originals that have been temporarily stored can be sent all at once.

2. Mail server

A mail server is an SMTP server used for an e-mail system. It transfers a received e-mail to a specified destination through a LAN or the Internet.

3. Client computer

An e-mail with a scan file attached is received from the mail server.

Check the content of the file using an appropriate application.

4. LDAP server

The LDAP server provides a directory service for search operations or inquiries from a client computer on the same network.

You can use the LDAP server to search for e-mail information when the server is used as data base to manage user authentication and e-mail accounts.

Scan to Folder

You can send scan files to shared network folders, FTP server folders, or NetWare folders.

Reference

p.31 "Sending Scan Files by Scan to Folder"

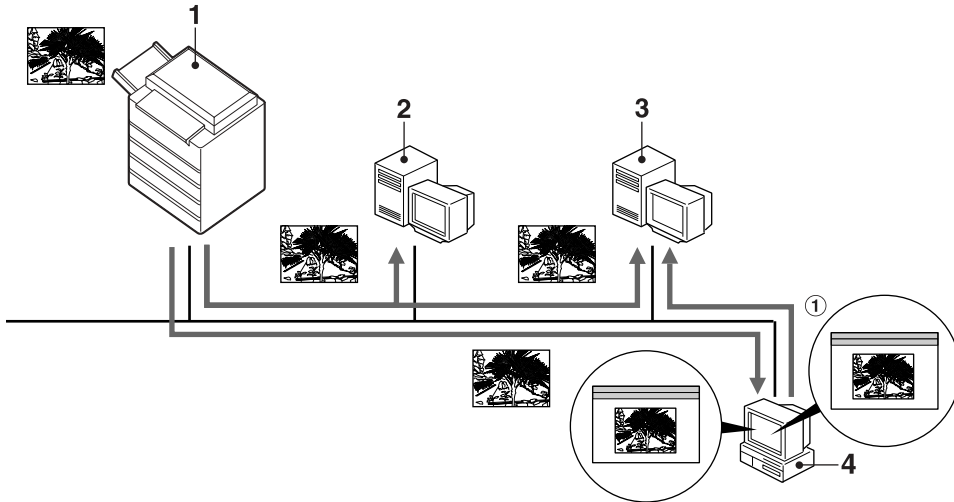

ZZZ507D

1. This machine

You can send scan files to shared network folders, FTP server folders, or NetWare folders. To send scan files to shared network folders, use the SMB protocol. To send scan files to FTP server folders, use the FTP protocol. To send scan files to NetWare folders, use the NCP protocol. In combination with the file storage function, scan files from multiple originals that have been temporarily stored can be sent all at once.

2. FTP server

The FTP server is a server that provides file transfer services among computers on the same network. A scan file that is sent to the FTP server is stored, and the stored files can be downloaded by a client computer that logs on to the FTP server.

3. NetWare server

You can use this server to share files over the network via NetWare. By sending image data to the server, images can be stored on the server for download by computers on the network. To download images, a computer must be running the NetWare client and be logged onto the server.

4. Client computer

A scan file that is sent from the machine is received in shared folders. Check the content of the file using an appropriate application.

Store

You can store scanned documents as files on the machine's hard disk. The stored scan files can be viewed, copied, deleted, or retrieved over the network using DeskTopBinder from a client computer. You can also view, delete or download scan files over the network using Web Image Monitor from the client. A file can be searched for using the user name or the file name. Also, others can be kept from viewing a file by setting a password for the file.

Also, stored files can be sent by e-mail or Scan to Folder, or delivered. When sending stored files by e-mail, you can select to send only the URL addresses of file locations.

Reference

p.47 "Storing Files"

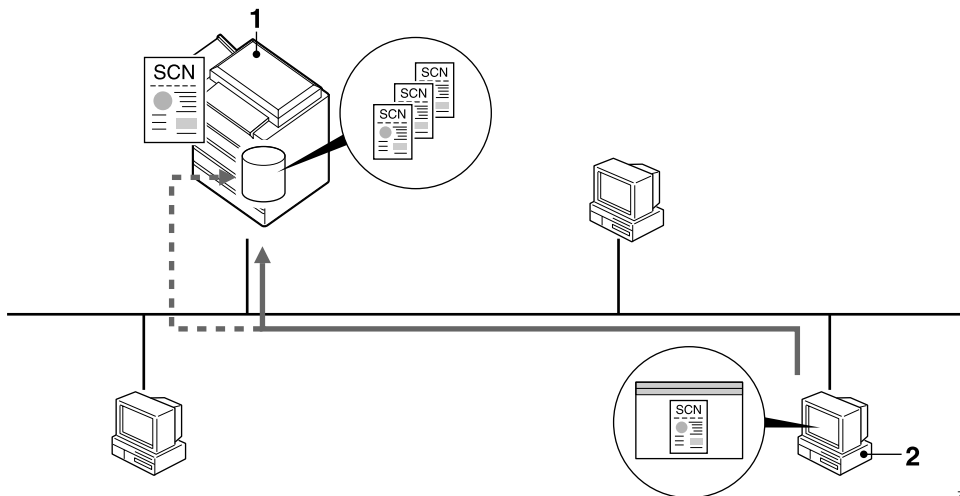

ZZ2603S

1. This machine

A scan file from the originals scanned by the machine is stored.

2. Client computer

A stored file can be viewed, copied, or deleted by connecting to the machine using DeskTopBinder.

Also, a file stored in the machine can be viewed, downloaded, or deleted using Web Image Monitor.

Reference

For details about DeskTopBinder, see the DeskTopBinder manuals. See p.i "Manuals for This Machine".

For details about Web Image Monitor, see the Web Image Monitor Help.

Network Delivery Scanner

A scan file from the originals scanned by the machine is stored in the delivery server and delivered to the folders of client computers on the same network.

Reference

p.61 “Delivering Scan Files”

Note

- ❑ To use the delivery scanner function, a delivery server installed with the ScanRouter delivery software is required.
- ❑ When the ScanRouter delivery software is used, the machine can also deliver scan files using e-mail, store scan files in the document management server.

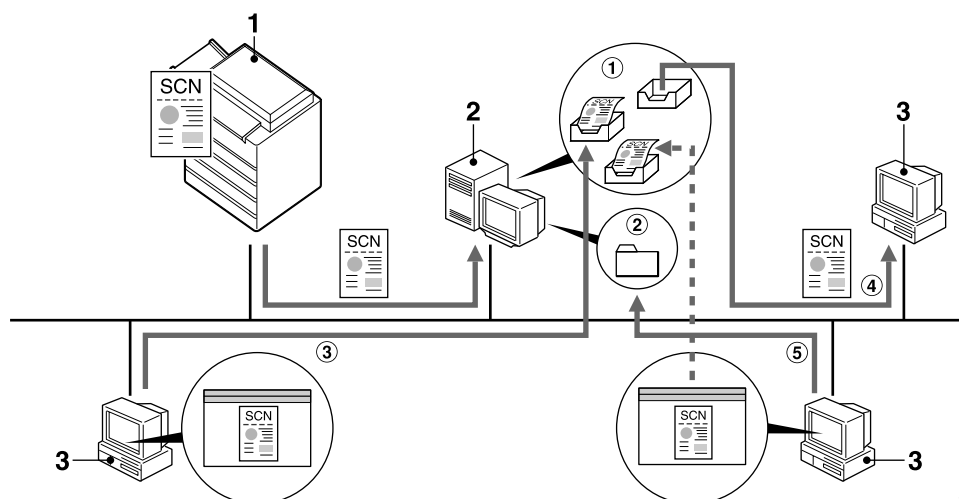

ZZZ604S

1. This machine

A scan file from the originals scanned by the machine is sent to the delivery server. In combination with the file storage function, scan files from multiple originals that have been temporarily stored can be delivered all at once. See p.69 “Simultaneous Storage and Delivery”.

2. Delivery server

The ScanRouter delivery software is installed in this computer which is used as a delivery server.

A received file is delivered to the in-tray of the specified destination (① in the figure). According to the settings of the in-tray, the file is stored in the in-tray or in a folder (② in the figure).

3. Client computer

The contents of a stored file can be checked in the following ways:

- View the file in the in-tray using DesktopBinder to check the contents. (③ in the figure)
- Use Auto Document Link to receive the file stored in the in-tray, and check the contents with an appropriate application. (④ in the figure)
- Access the folder where the file is stored via the network, and check the contents with an appropriate application. (⑤ in the figure)

Reference

For details about DeskTopBinder, or Auto Document Link, see the respective manuals. See p.i “Manuals for This Machine”.

Network TWAIN Scanner

The scanner function of this machine can be used from a client computer via a network using Ethernet, optional IEEE 1394 (IP over 1394), or optional IEEE 802.11b (wireless LAN).

Reference

p.73 “Using the Network TWAIN Scanner Function”

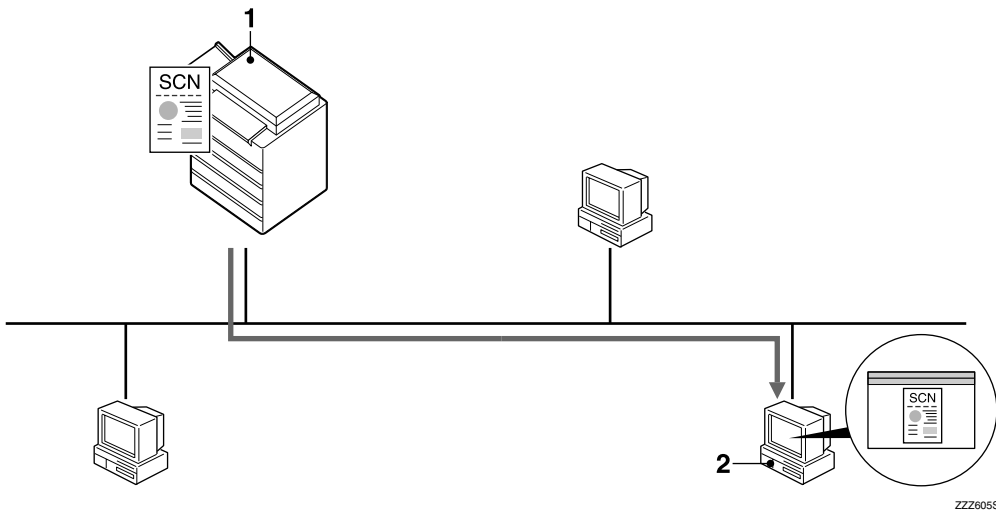

1. This machine

The scanner function of the machine can be used from a client computer via a network.

2. Client computer

Originals are scanned using the TWAIN Driver from an application.

Note

- ❑ When using the machine as a network TWAIN scanner, it is not necessary to press the **[Scanner]** key on the control panel. When the TWAIN Driver becomes active on a client computer, the display automatically switches to the following screen.

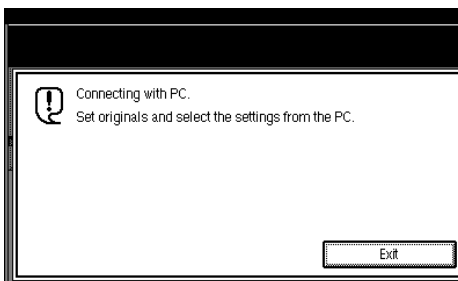

- ❑ Press **[Exit]** to use functions other than the network TWAIN scanner function.

Installing Software

This section describes how to install the software supplied on the “Scanner Driver and Document Management Utility” CD-ROM.

Reference

For details about the software on the CD-ROM and the system requirements of the software, see p.120 “Software Supplied on CD-ROM”.

Quick Install

When the CD-ROM is inserted into a client computer running Windows 95/98/Me/2000/XP, Windows Server 2003, or Windows NT 4.0, the installer starts automatically (Auto Run) to install various software.

Note

- If Plug and Play starts, click **[Cancel]** in the **[New Hardware Found]**, **[Device Driver Wizard]**, or **[Found New Hardware Wizard]** dialog box, and then insert the CD-ROM. The **[New Hardware Found]**, **[Device Driver Wizard]**, or **[Found New Hardware Wizard]** dialog box appears depending on the operating system used.
- Auto Run may not automatically work with certain operating system settings. If this happens, launch “SETUP.exe” on the CD-ROM root directory.
- To disable Auto Run, press the **[SHIFT]** key when inserting the CD-ROM into the drive and keep it pressed until the computer finishes reading from the CD-ROM.

- If **[Cancel]** is selected during installation, the installation will be stopped and all the remaining software will not be installed. If **[Cancel]** has been selected, reinstall the remaining software after restarting the client computer.
- For information about the software that can be installed by Auto Run, see p.120 “Software Supplied on CD-ROM”.

Limitation

- For installation under Windows 2000/XP, Windows Server 2003, or Windows NT 4.0, log on as an Administrators group member.

TWAIN Driver

To use the machine as a network TWAIN scanner, it is essential to install the TWAIN Driver on a client computer.

If an application that supports TWAIN is not installed on the client computer, it is also necessary to install DeskTopBinder. For information about the installation of DeskTopBinder, see p.11 “DeskTopBinder”.

Preparation

Before installation, check the system requirements for the TWAIN Driver. For details about the system requirements, see p.120 “Software Supplied on CD-ROM”.

Note

- Use Auto Run for installation.

- 1** Start Windows, and then insert the CD-ROM labeled “Scanner Driver and Document Management Utility” into the CD-ROM drive of the client computer.

Reference

If the installer does not start automatically, see p.10 “Quick Install”.

- 2** Click [TWAIN Driver].

The Software Setup screen appears.

- 3** The installer of the TWAIN Driver starts. Follow the instructions.

Note

- When the installation is complete, a message about restarting the client computer may appear. In this case, restart the client computer.
- After the installation is complete, a folder with the name of the machine in use is in [Program] on the [Start] menu. Help can be displayed from here.
- Notes on using the network TWAIN scanner are provided in “Readme.txt”. Be sure to read them before use.

DeskTopBinder

To check an in-tray or to retrieve files using the network delivery scanner function, you must install DeskTopBinder on the client computer.

Preparation

Before installation, check the system requirements for DeskTopBinder. See p.120 “Software Supplied on CD-ROM”.

Note

- Use Auto Run for installation.
- To use the network delivery scanner function, you need to install the ScanRouter delivery software (optional) on the computer used as the delivery server.

- 1** Start Windows, and then insert the CD-ROM labeled “Scanner Driver and Document Management Utility” into the CD-ROM drive of the client computer.

The CD-ROM Launcher screen appears.

- 2** Click [DeskTopBinder Lite].

The DeskTopBinder Lite Setup screen appears.

Reference

For information about the subsequent installation procedure, see *Setup Guide* that can be displayed from the Setup screen of DeskTopBinder.

User Authentication

1

When user authentication (User Code Authentication, Basic Authentication, Windows Authentication, or LDAP Authentication, Integration Server Authentication) is set, the authentication screen is displayed. Unless a valid user name and password are entered, operations are not possible with the machine. Log on to operate the machine, and log off when you are finished operations. Be sure to log off to prevent unauthorized users from using the machine.

Note

- ❑ Consult the User Administrator about your login user name, password, and user code. For details about the various types of user authentication, consult the appropriate administrators.
- ❑ For user code authentication, enter a number registered in the address book as **[User Code]**.

User Code Authentication (Using the Control Panel)

When user code authentication is set, the following screen appears.

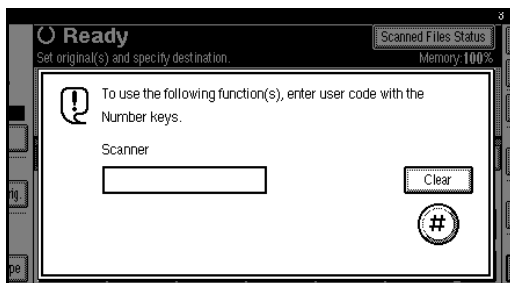

Enter a User Code (eight digit), and then press **[#]**.

Note

- ❑ You do not need to log off after user code authentication.

Login (Using the Control Panel)

Follow the procedure below to log in when Basic Authentication, Windows Authentication, or LDAP Authentication, Integration Server Authentication is set.

- 1** Press **[Enter]** for **[Login User Name]**.

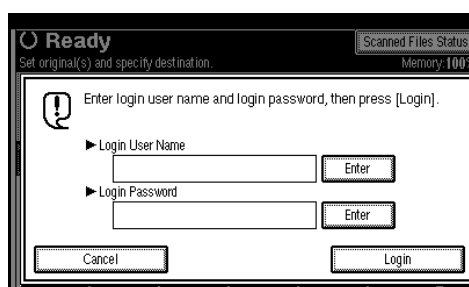

- 2** Enter a login user name, and then press **[OK]**.
- 3** Press **[Enter]** for **[Login Password]**.
- 4** Enter a login password, and then press **[OK]**.
- 5** Press **[Login]**.

When the user is authenticated, the screen for the function you are using appears.

Log Off (Using the Control Panel)

Follow the procedure below to log off when Basic Authentication, Windows Authentication, or LDAP Authentication, Integration Server Authentication is set.

1 Press [User Tools / Counter].

2 Press [Logout].

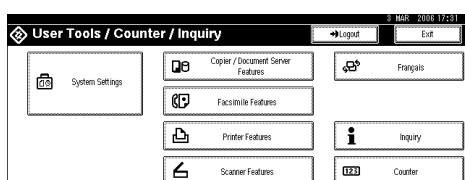

3 Press [Yes].

4 Press [User Tools / Counter].

Programming E-mail Addresses and Folders

1

You can program e-mail addresses and folders using Address Book Management in the Administrator Tools menu under System Settings.

You can also register the programmed e-mail addresses and folders in a Group.

Note

- You can register entries in the address book using Web Image Monitor or SmartDeviceMonitor for Admin. For details about installing SmartDeviceMonitor for Admin, see "Monitoring and Configuring the Printer", *Network Guide*. For details about registering addresses, see each application's Help.
- Depending on the machine type, you may not be able to use the machine when it is updating the address book using CSV files (retrieved using SmartDeviceMonitor for Admin) that contain user codes.

Reference

"E-mail Destination", *General Settings Guide*

"Registering Folders", *General Settings Guide*

"Registering Destinations to a Group", *General Settings Guide*

2. Sending Scan Files by E-mail

Scan files can be sent from this machine to specified destinations using the e-mail system. This chapter explains the preparation for sending files by the e-mail system, various display screens, procedures for sending, and how to check the sending results when this function is used.

Preparation for Sending by E-mail

To send scan files by the e-mail system, the preparation described below is required.

Note

- If you establish an e-mail server on the network, set up the e-mail server on the network in advance. For information about setting up an e-mail server, see the manuals of the mail server to be used and the software to be installed.

1

Connect to Network

Connect the machine to the network with an Ethernet cable or IEEE 1394 cable, or use wireless LAN.

To connect using an IEEE 1394 cable, the IEEE 1394 interface board is required. To connect using wireless LAN, the IEEE 802.11b interface unit is required.

See *Network Guide*.



2

Make System Settings

To send scan files by e-mail, the following [**System Settings**] settings must be specified correctly. (Certain other settings must also be specified.)

- IP address
- subnet mask
- DNS server
- SMTP server name

For details about making settings and other settings, see *Network Guide*. You also need to register destinations and other information in the address book. For details, see *General Settings Guide*.



3

Make Scanner Settings

Make settings for sending e-mail such as file type priority and sender's default.

See p.110 "Send Settings".

E-mail Screen

The e-mail is as shown.

The function items displayed serve as selector keys. You can select or specify an item by lightly pressing it. When you select or specify an item on the display panel, it is highlighted like **Full Size**. Keys that cannot be selected appear like **OK**.

2

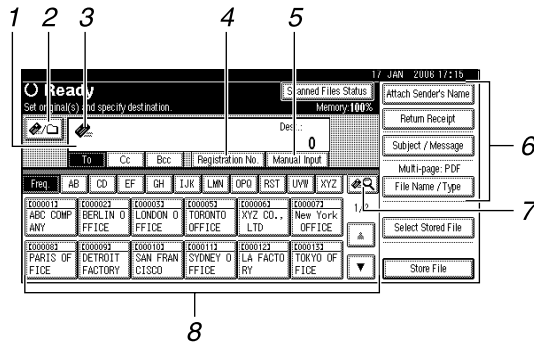

1. Destination field

Displays the selected destination. If multiple destinations are selected, the destinations are displayed in the order they were selected by pressing **[▲Prev.]** or **[▼Next]**.

Note

To check the selected destinations, press the **[Check Modes]** key.

2. [E-mail/Scan] E-mail/Scan to Folder

Press to switch between the e-mail function and the Scan to Folder function. You can send a file to e-mail destinations and Scan to Folder destinations at the same time.

3. E-mail icon (✉)

Indicates that the e-mail screen is displayed.

4. [Registration No.]

Press to specify a destination using a five digit registration number.

5. [Manual Input]

When specifying a destination that is not listed, press **[Manual Input]**, and then enter the destination using the soft keyboard.

6. [Attach Sender's Name] [Return Receipt] [Subject / Message] [File Name / Type]

Press to specify the sender, return receipt setting, subject, message, and names and formats of the files you want to send.

7. [Switch] Switch Destination List/Search/Switch Title

Press to switch a destination from the delivery server list to a destination list of this machine, to search for a destination.

8. Destination list

Displays the destinations registered in the delivery server or this machine.

Note

When the entire list does not fit on one screen, **[▲]** or **[▼]** can be used to scroll through the list.

Group destinations are denoted by this symbol (###).

Sending Scan Files by E-mail

Procedure for Sending E-mail

A scan file is sent after scan settings and destinations are specified.

1 Press the **[Scanner]** key.

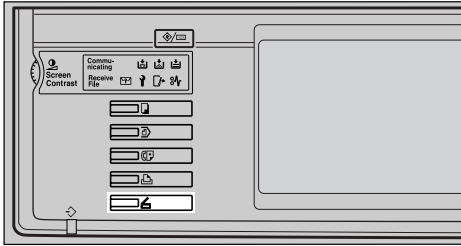

ZZZ607S

Note

- The illustration is an example. The actual appearance may be different.

2 Make sure that no previous settings remain.

Note

- If a previous setting remains, press the **[Clear Modes]** key.

3 Place originals.

Reference

The procedure for placing originals is the same as that for placing originals for copying. For details about placing originals, see "Placing Originals", *Copy Reference*.

4 Make settings for original orientation, the sides scanned, and other settings if necessary.

Reference

p.79 "Making the Settings Related to the Orientation of the Original and Scanned Sides"

5 Make the scan settings.

Reference

There are two ways to specify scan settings, as described below:

- Configure each setting for scanning. For details, see p.77 "Specifying Scan Settings".
- Recall registered settings. For details, see p.86 "Recalling a Program".

6 If the network delivery scanner screen appears, switch to the e-mail screen.

1 Press **[E-mail]**.

2 Press **[Switch Destination List]**.

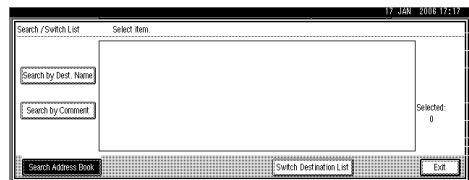

3 Press **[E-mail]**.

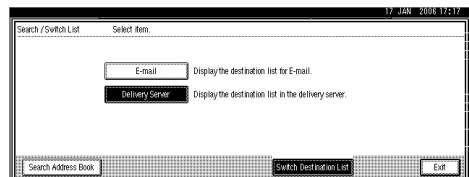

4 Press **[Exit]**.

The e-mail screen or Scan to Folder screen appears.

5 If the Scan to Folder screen appears, press **[E-mail]**.

The e-mail screen appears.

7 Specify the destination.

You can specify the destination in the following ways:

- Select it from the destination list.
- Specify its registration number.
- Enter the e-mail address directly.
- Search for it in the destination list.
- Search for it in the LDAP server.

Note

- Destinations in the destination list and registration numbers must be registered in advance in **[System Settings]**. For details, see “Registering Addresses and Users for Facsimile/Scanner Functions”, *General Settings Guide*.
- For details about the maximum number of destinations that can be selected for each transmission, see p.122 “E-mail”.
- Before selecting the destination, be sure to select **[To]**. If necessary, select **[Cc]** or **[Bcc]** and the respective destinations.
- Depending on the security settings, certain destinations may not be displayed.

Selecting a destination from the list

1 Select the destination.

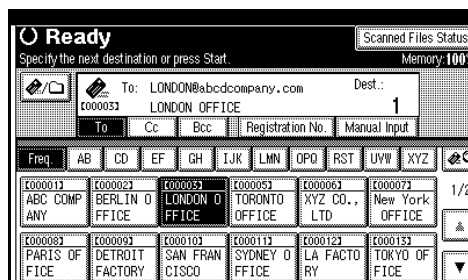

The selected destination is highlighted and also displayed in the destination field at the top of the screen.

Note

- If the target destination does not appear, take one of the following steps:
 - Display the destination by selecting its initial letter from the title.
 - Display the destination by pressing **[▲]** or **[▼]**.

2 To select more destinations, repeat steps 1.

Note

- To deselect a destination, press the destination once more, or press **[▲Prev.]** or **[▼Next]** to display the destination in the destination field, and then press the **[Clear/Stop]** key.

Using a registration number to select a destination

- ① Press [**Registration No.**].
- ② Enter the five digit registration number that has been assigned to a destination folder using the number keys.

If the entered number is less than five digits, press the [**#**] key after the last number.

Example: To enter 00003

Press the [**3**] key, and then press the [**#**] key.

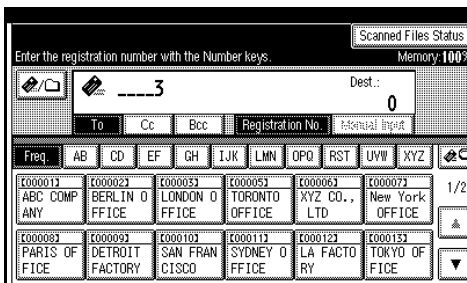

- ③ To select more destinations, repeat steps ① to ②.

Note

- To deselect a destination, press [**▲Prev.**] or [**▼Next**] to display the destination in the destination field, and then press the [**Clear/Stop**] key.

Manual entry of an e-mail address

- ① Press [**Manual Input**].

The soft keyboard appears.

Note

- Depending on the security settings, [**Manual Input**] may not be displayed.

- ② Enter the e-mail address.

Note

- For details about the maximum number of characters that can be entered, see p.122 "E-mail".
- It is possible to enter alphanumeric characters and periods. The symbols () \ , ; : " and spaces cannot be entered. For details, see p.122 "E-mail".

- ③ Press [**OK**].

Note

- If you press [**ProgDest**], a screen for registering and changing address book entries appears. Using this screen, you can register e-mail addresses directly into the address book.
- To change an e-mail address entered, press [**Change**] located on the left side of the destination field. The soft keyboard appears. Make any changes, and then press [**OK**].
- To check the selected destinations, press the [**Check Modes**] key.
- Depending on the security settings, [**ProgDest**] may not be displayed.

- ④ To enter more destinations, repeat steps ① to ③.

Note

- To deselect a destination, press [**▲Prev.**] or [**▼Next**] to display the destination in the destination field, and then press the [**Clear/Stop**] key.

Searching for a destination in the destination list

1 Press [F5].

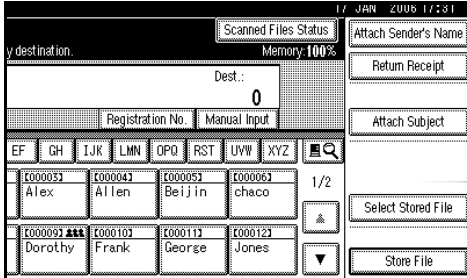

2 Press [Search by Dest. Name].

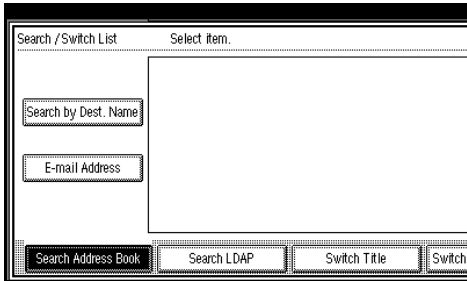

The soft keyboard appears.

Note

- To search using an e-mail addresses, press [E-mail Address].

3 Enter part of the destination name.

Note

- Enter the first character or characters of the destination name.
- It is also possible to perform a combined search using [Search by Dest. Name] and [E-mail Address].

4 Press [OK].

5 Select a destination.

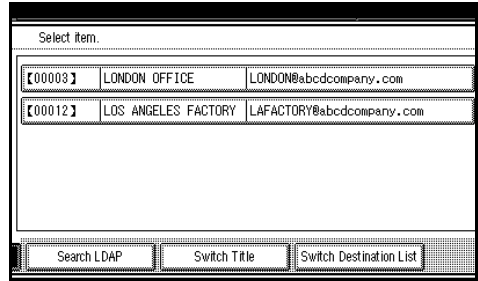

6 Press [Exit].

Searching for a destination in the LDAP server

1 Press [F5].

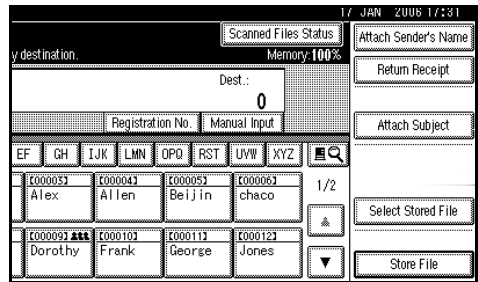

2 Press [Search LDAP].

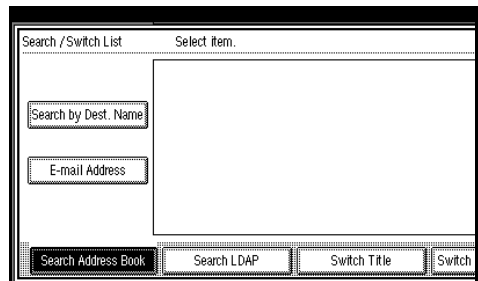

3 Press [Select Server].

4 Select the LDAP server.

Note

- The LDAP server can be registered in advance in [System Settings]. For details, see *Network Guide*.

- ❑ Make sure that the LDAP server you want to search is selected and highlighted. If a server is not selected, the search is not performed and an error message appears.

5 Press [OK].

6 Press [Advanced Search].

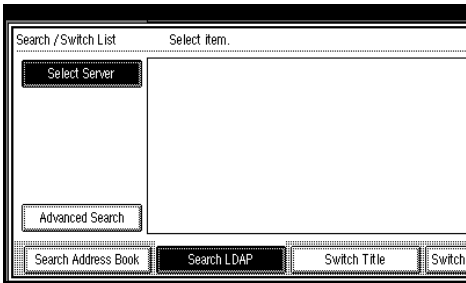

7 Enter a character string related to the destination for a search condition such as [Name], [E-mail Address], [Fax Number], [Company Name], or [Department Name].

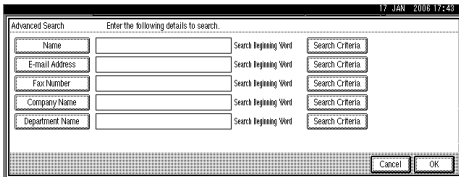

Note

- ❑ Each search condition (Name, E-mail Address, Fax Number, Company Name, and Department Name) corresponds to a item that is registered in the LDAP server.
- ❑ If you select a search condition setting, a soft keyboard appears. Enter a text string according to the search criteria.

- ❑ If you select [▶ Search Options] in [Program / Change / Delete LDAP Server] in [Administrator Tools] in [System Settings], you can add a field for LDAP search. For details, see *Network Guide*.

- ❑ When the search condition [Name] is used for searching, whether the first name or surname is searched for depends on the setting made by the administrator. For example, if you want to search for "John Doe", enter "John" or "Doe" according to the setting made by the administrator. Consult your administrator for which name to use.

8 Press [Search Criteria] corresponding to each item, and then select criteria from the list displayed.

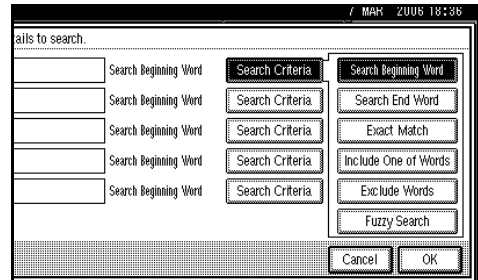

Note

- ❑ You can select criteria from the following list:
 - [Search Beginning Word]: The names which start with the entered character or characters are targeted. For example, to search for "ABC", enter "A".
 - [Search End Word]: The names which end with the entered character or characters are targeted. For example, to search for "ABC", enter "C".

- **[Exact Match]:** The names which correspond to an entered character or characters are targeted.
For example, to search for "ABC", enter "ABC".
- **[Include One of Words]:** The names which contain an entered character or characters are targeted.
For example, to search for "ABC", enter "A", "B", or "C".
- **[Exclude Words]:** The names which do not contain an entered character or characters are targeted.
For example, to search for "ABC", enter "D".
- **[Fuzzy Search]:** a vague search (The function of this vague search depends on the system supported by the LDAP server.)

9 Press [OK].

Note

- The e-mail address searched for in the LDAP server cannot be specified correctly if it contains too many characters. For details about the maximum number of characters that can be entered, see p.122 "E-mail".
- If a user name and password for the LDAP server authentication are not set, a log-on screen appears. Enter a user name and password.
- Multiple e-mail addresses can be registered for one person, but a search will only find one e-mail address per person. Depending on the LDAP server, the address which was registered first is generally found.

- To display details about the destination, press [Details].

10 Select a destination.

11 Press [Exit].

Note

- If you press [ProgDest], a screen for registering and changing address book entries appears. Using this screen, you can register e-mail addresses directly into the address book.

Checking selected destinations

1 Use the destination field at the top of the screen to check which destinations are selected.

Note

- Press [▲Prev.] or [▼Next] to scroll through the list. Destinations are displayed in the order they were selected.
- To check the selected destinations, press the [Check Modes] key.

8 Select the file type if necessary.

1 Press [File Name / Type].

2 Press [File Type]

3 Select the file type of the file.

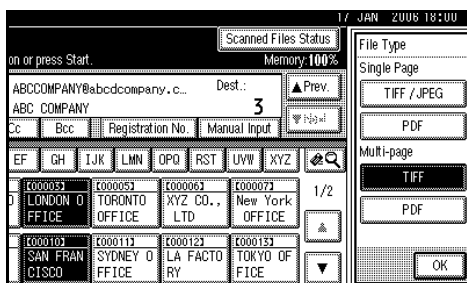

4 Press [OK] twice.

9 Specify the file name if necessary.

1 Press [File Name / Type].

2 Press [File Name].

The soft keyboard appears.

3 Enter a file name.

4 Press [OK] twice.

10 Specify the e-mail sender.

You can specify the sender in the following ways:

- Select the sender from the list.
- Enter the registration number of the sender using the number keys.
- Search for the sender.

 **Note**

Register the sender in advance under [System Settings]. For details, see "Registering Addresses and Users for Facsimile/Scanner Functions", *General Settings Guide*.

If you specify the sender, information about the sender is included in the file being sent. The name of the specified sender is automatically placed in the from field of the e-mail so that the sender can be identified when the e-mail is received.

Depending on system settings, the administrator's e-mail address may appear automatically in the e-mail header's from field. To change the address, specify the sender in Step 10.

To prevent misuse of a sender name, we recommend you set protection code for that sender name. See "Registering a Protection Code" *General Settings Guide*.

Depending on the security settings, [Attach Sender's Name] may be selected as the user name when logging in.

Selecting a sender from the list

1 Press [Attach Sender's Name].

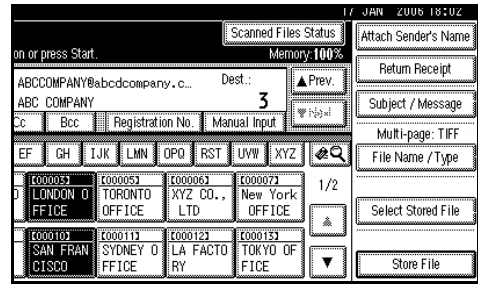

2 Select the sender.

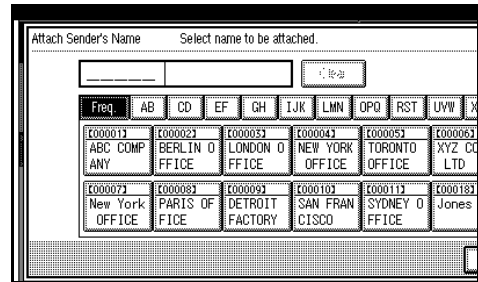

 **Note**

When a protection code has been set, a screen for entering the protection code appears after selecting the sender. Enter the protection code, and then press [OK]. If the protection code you entered is correct, the sender name is displayed.

3 Press [OK].

Using a registration number to specify a sender name

1 Press [Attach Sender's Name].

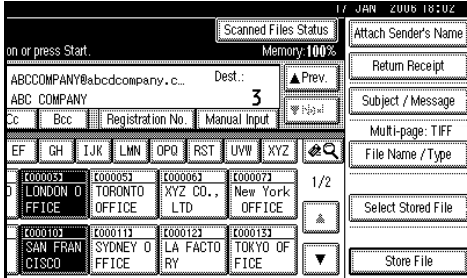

2 Enter the five digit registration number that has been assigned to a destination folder using the number keys.

If the entered number is less than five digits, press the [#] key after the last number.

Example: To enter 00006

Press the [6] key, and then press the [#] key.

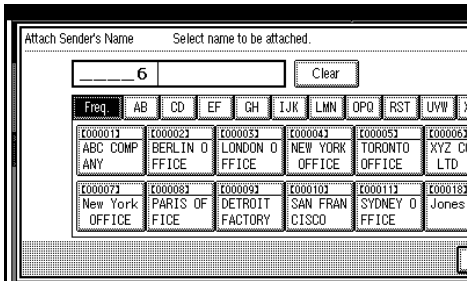

Note

- When a protection code has been set, a screen for entering the protection code appears after selecting the sender. Enter the protection code, and then press [OK]. If the protection code you entered is correct, the sender name and [Return Receipt] are displayed.

3 Press [OK].

Searching for a sender

1 Press [Attach Sender's Name].

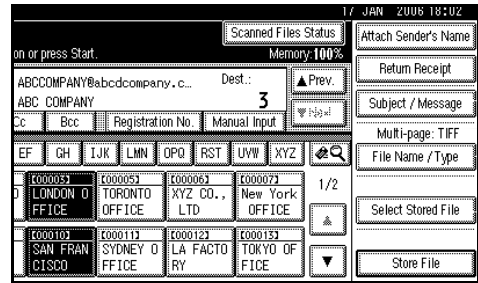

2 Press [Search].

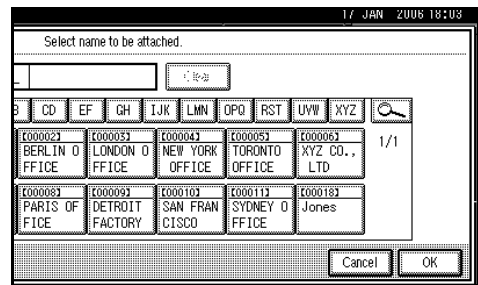

3 Press [User (Dest.) Name].

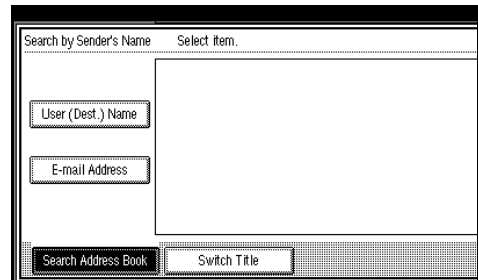

The soft keyboard appears.

Note

- To search for an e-mail address, press [E-mail Address].

4 Enter part of the sender name.

Note

- Enter the first character or characters of the sender name.

- It is also possible to perform a combined search using [User (Dest.) Name] and [E-mail Address].

5 Press [OK].

6 Select the sender.

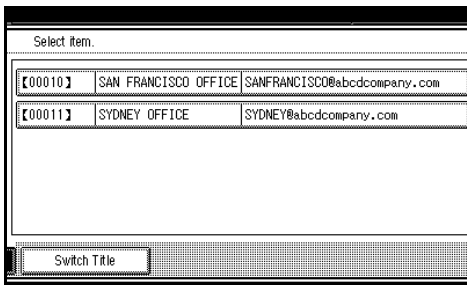

Note

- When a protection code has been set, a screen for entering the protection code appears after selecting the sender. Enter the protection code, and then press **[OK]**. If the protection code you entered is correct, the sender name is highlighted.

7 Press [Exit].

8 Press [OK].

11 For a reception confirmation e-mail, press [Return Receipt].

Note

- To use **[Return Receipt]** you must:
 - Log on as a user
 - Specify the sender in Step 10
- When **[Return Receipt]** is selected, an e-mail notifying that the e-mail has been read by the destination party is sent to the sender selected Step 10. However, if the mailing software used by the destination party does not support MDN (Message Disposition Notification), the e-mail may not be sent.

12 Specify a subject if necessary.

Note

- To specify a subject, you can select it from the list, enter it directly, or combine selecting and entering it.

- For details about the maximum number of characters that can be entered, see p.122 “E-mail”.
- When a subject has been specified, this information is added to the scan file. The subject is automatically placed in the subject field of the e-mail.
- The subjects that can be selected from the list must be registered in **[System Settings]** in advance. See *Network Guide*.

The procedure to specify the subject “[**Urgent**] New product appearance” is explained as an example here.

1 Press [Subject / Message].

2 Press [Attach Subject].

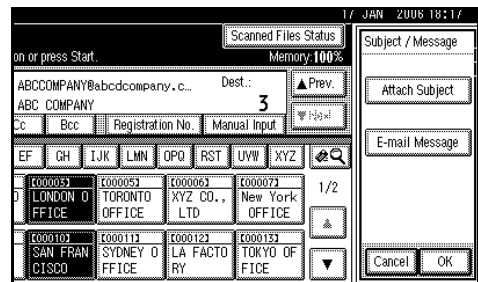

3 Select the subject [Urgent].

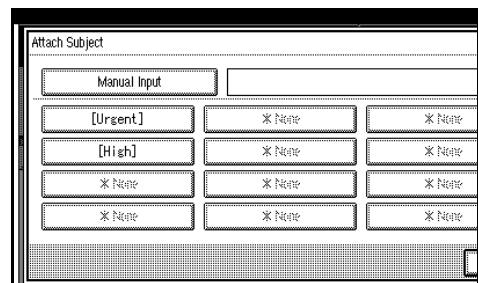

4 Press [Manual Input].

The soft keyboard appears.

5 Enter the subject “New product appearance”.

6 Press [OK].

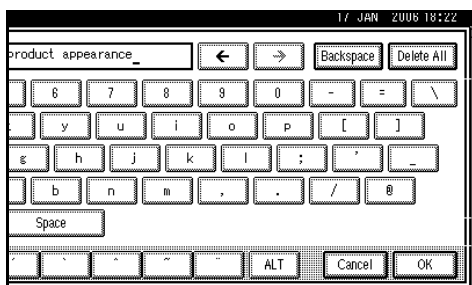

7 Press [OK] twice.

13 Enter a message if necessary.

Note

- For details about the maximum number of characters that can be entered, see p.122 “E-mail”.
- When a message has been entered, this information is added to the scan file.
- The messages that can be selected from the list must be registered in [System Settings] in advance. See *Network Guide*.
- A message can be selected from the list or entered directly.

Selecting a message from the list

1 Press [Subject / Message].

2 Press [E-mail Message].

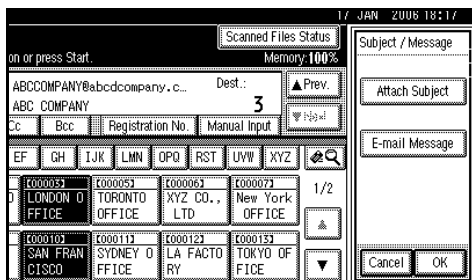

3 Select a message.

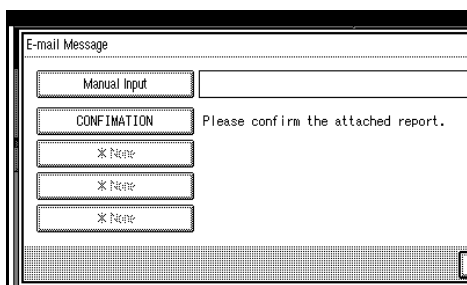

4 Press [OK] twice.

Manual entry of a message

1 Press [Subject / Message].

2 Press [E-mail Message].

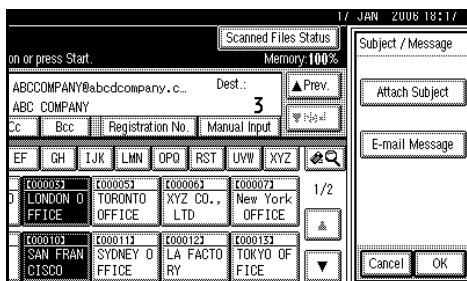

3 Press [Manual Input].

The soft keyboard appears.

4 Enter the message “Thank you for what you did yesterday”.

5 Press [OK] three times.

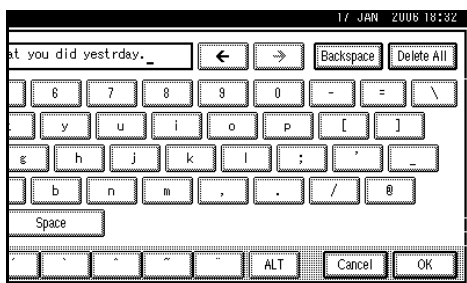

14 Press the [Start] key.

Note

- For details about the maximum size of the scan file and maximum number of pages that can be sent, see p.122 “E-mail”.

- ❑ To interrupt scanning, press the **[Clear/Stop]** key or press **[Stop]** on the display panel.
- ❑ When placing multiple originals one-by-one, place the next original. For details, see p.82 “Scanning Originals in Several Times”.

Simultaneous Storage and Sending by E-mail

You can use the e-mail function and the storage function together.

The scan file is sent by e-mail and at the same time is stored.

Note

- ❑ This section explains mainly the procedure for simultaneous storage and sending of e-mail. For details, see p.17 “Procedure for Sending E-mail”.
- ❑ The file stored when simultaneously storing a file and sending it by e-mail cannot be resent in the e-mail screen. To resend the file, select the file in the **[Select Stored File]** screen and send it. See p.54 “Sending Stored Files by E-mail or Scan to Folder, or Delivering”.

1 Place originals.

Note

- ❑ The procedure for placing originals is the same as that for placing originals for copying. For details about placing originals, see “Placing Originals”, *Copy Reference*.

2 Make settings for original orientation, the sides scanned, and other settings if necessary.

Reference

p.79 “Making the Settings Related to the Orientation of the Original and Scanned Sides”

3 Make the scan settings.

Note

- ❑ There are two ways to specify scan settings, as described below:
 - Configure each setting for scanning. For details, see p.77 “Specifying Scan Settings”.
 - Recall registered settings. For details, see p.86 “Recalling a Program”.

4 Specify the destination.

5 Specify the sender and a subject.

6 Press [Store File].

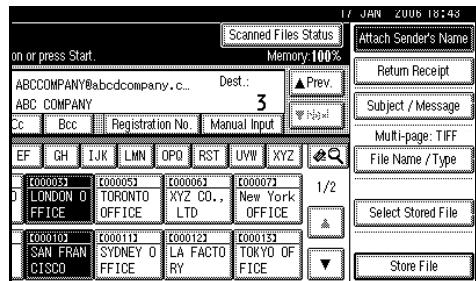

7 Make sure [Send & Store] is selected.

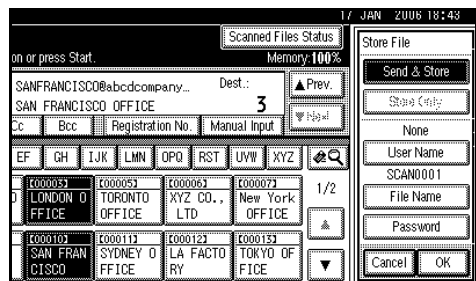

8 Specify file information if necessary.

 **Reference**

For details about specifying file information, see p.49 “Specifying file information”.

2

9 Press [OK].

10 Press the [Start] key.

Simultaneously storing files and sending their URL addresses

You can store scan files and simultaneously send the URL addresses of their locations by e-mail. In this case, scan files will not be attached to the e-mail. Transmitted URL addresses allow a stored file to be viewed, deleted, or downloaded over the network using Web Image Monitor. This is useful if you cannot attach files to e-mail due to network restrictions.

 **Note**

- Settings for the above functions must be made in advance under **[Scanner Features]**. See p.112 “Stored File E-mail Method”.
- For details about the transmission procedure, see p.27 “Simultaneous Storage and Sending by E-mail”.
- If you want to always e-mail the URL addresses of scan file locations, Under **[Scanner Features]**, **[Send Settings]**, set **[Stored File E-mail Method]** to **[Send URL Link]** and **[Store File Priority]** to **[Send & Store]**. See p.112 “Stored File E-mail Method” and p.112 “Store File Priority”.

Checking the E-mail Results

The sending results can be checked.

Note

- For details about the maximum number of sending operations that can be checked, see p.111 “Print & Delete Scanner Journal”.

Items that can be checked

- Date / Time**
The date and time the e-mail was sent or the date and time “Done”, “Error” or “Cancelled” was confirmed is displayed.
- Destination**
The sending function (e-mail, Scan to Folder, or delivery function) used is displayed with an icon.
When multiple destinations were selected, the first selected destination is displayed.
- Sender**
- File Name**
The file name is displayed only when a file is stored at the same time and when a stored file is sent.
- Status**
One of the following status is displayed: “Done”, “Sending...”, “Waiting...”, “Error”, or “Cancelled”.

- Press **[Scanned Files Status]** on the e-mail screen.

Scanned Files Status

Memory 100%

Attach Sender's Name

Return Receipt

Attach Subject

Select Stored File

Store File

EF	GH	IJK	LMN	OPO	RST	UVW	XYZ
[E00003]	[E00004]	[E00005]	[E00006]				
Alex	Allen	Beijin	chaco				
[E00009]	[E00010]	[E00011]	[E00012]				
Dorothy	Frank	George	Jones				

- Check the displayed records.

Scanned Files Status

The current scanned files status is displayed.

Date / Time	Destination	Sender	File Name	Status
17 Jan. 1902	ABC COMPANY	Jones	SCAN	Cancelled
17 Jan. 1902	BERLIN OFFICE + 2	Jones	SCAN	Done
17 Jan. 1901	ABC COMPANY		SCAN	Cancelled
17 Jan. 1859	ABC COMPANY	BERLIN OFFICE		Cancelled
17 Jan. 1855	Allen	Beijin		Done

Note

- Depending on the security settings, certain records may not be displayed.
- One screen shows the records for five sending operations. Use **[▲Prev.]** or **[▼Next]** to scroll through the list.
- When the status of a file is “Waiting...”, the sending can be canceled by selecting that file, and then pressing **[Cancel]**.
- Press **[Print]** to print the whole journal.

- Press **[Exit]**.

The e-mail screen appears.

3. Sending Scan Files by Scan to Folder

You can send scan files to shared network folders, FTP server folders, or NetWare folders. This chapter explains the preparation for sending files by Scan to Folder, various display screens, procedures for sending, and how to check the sending results when this function is used.

Preparation for Sending by Scan to Folder

To send scan files by Scan to Folder, the preparation described below is required.

1

Connect to Network

Connect the machine to the network with an Ethernet cable or IEEE 1394 cable, or use wireless LAN.

To connect using an IEEE 1394 cable, the IEEE 1394 interface board is required. To connect using wireless LAN, the IEEE 802.11b interface unit is required.

See *Network Guide*.



2

Make System Settings

To send scan files by Scan to Folder, the following **[System Settings]** settings must be specified correctly. (Certain other settings must also be specified.)

- IP address
- subnet mask

For details about making settings and other settings, see *Network Guide*. You also need to register destinations and other information in the address book. For details, see *General Settings Guide*.



3

Make Scan Settings

Make settings for sending such as compression and file type priority.

See p.110 "Send Settings".

Note

- Sending files using SMB is available only under a NetBIOS over TCP/IP environment. Sending files using SMB is not available under a NetBEUI environment.
- Even when settings made with the control panel, Web Image Monitor, Telnet, or other methods do not permit the use of SMB and FTP sending files is still possible.

Scan to Folder Screen

The Scan to Folder screen is as shown.

The function items displayed serve as selector keys. You can select or specify an item by lightly pressing it. When you select or specify an item on the display panel, it is highlighted like **Full Size**. Keys that cannot be selected appear like **OK**.

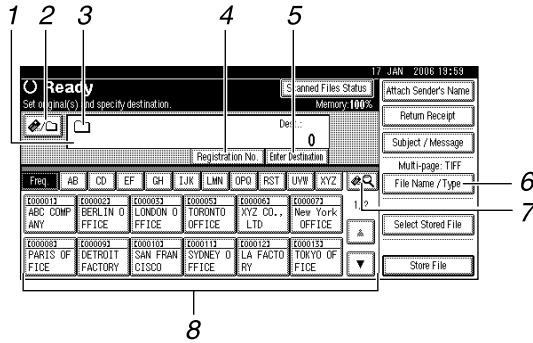

1. Destination field

Displays the selected destination. If multiple destinations are selected, the destinations are displayed in the order they were selected by pressing [**▲Prev.**] or [**▼Next**].

Note

To check the selected destinations, press the [**Check Modes**] key.

2. [**ⓧ**] E-mail/Scan to Folder

Press to switch between the Scan to Folder function and the e-mail function. You can send a file to Scan to Folder destinations and e-mail destinations at the same time.

3. Scan to Folder icon (📁)

Shows that the Scan to Folder screen is displayed.

4. [Registration No.]

Press to specify a destination using a five digit registration number.

5. [Enter Destination]

When specifying a destination that is not listed, press [**Enter Destination**], and then enter the destination using the soft keyboard.

6. [File Name / Type]

Press to specify the names and formats of the files you want to send.

Important

When the scan file is sent to destinations for e-mail and Scan to Folder at the same time, the sender, subject, and message are sent to the e-mail destinations only. [**Return Receipt**] is also used for e-mail transmission. For details, see p.15 "Sending Scan Files by E-mail".

7. [**🔍**] Switch Destination List/Search/Switch Title

Press to switch a destination in the delivery server list to a destination list of this machine, to search for a destination.

8. Destination list

Displays the destinations registered in the delivery server or this machine.

Note

When the entire list does not fit on one screen, press [**▲**] or [**▼**] to scroll through the list.

Group destinations are denoted by this symbol (###).

Sending Scan Files by Scan to Folder

Procedure for Sending by Scan to Folder

A scan file is sent after scan settings and destinations are specified.

1 Press the **[Scanner]** key.

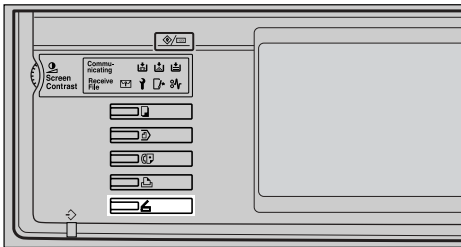

ZZZ607S

Note

- The illustration is an example. The actual appearance may be different.

2 Make sure that no previous settings remain.

Note

- If a previous setting remains, press the **[Clear Modes]** key.

3 Place originals.

Reference

The procedure for placing originals is the same as that for placing originals for copying. For details about placing originals, see "Placing Originals", *Copy Reference*.

4 Make settings for original orientation, the sides scanned, and other settings if necessary.

Reference

p.79 "Making the Settings Related to the Orientation of the Original and Scanned Sides"

5 Make the scan settings.

Reference

There are two ways to specify scan settings, as described below:

- Configure each setting for scanning. For details, see p.77 "Specifying Scan Settings".
- Recall registered settings. For details, see p.86 "Recalling a Program".

6 If the network delivery scanner screen appears, switch to the Scan to Folder screen.

1 Press **[ESC]**.

2 Press **[Switch Destination List]**.

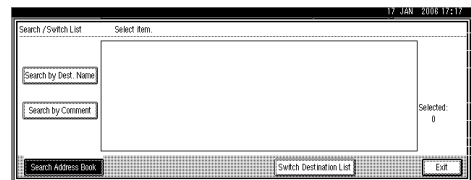

3 Press **[E-mail]**.

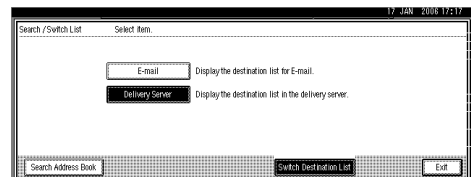

4 Press **[Exit]**.

The e-mail screen or the scan to folder screen appears.

5 If the e-mail screen appears, press **[ESC]**.

The Scan to Folder screen appears.

7 Specify the destination folder.

You can specify the destination folder in the following ways:

- Select it from the destination list.
- Specify its registration number.
- Directly enter the path for the folder of a client computer on the same network.
- Directly enter the path for the folder on the FTP server.
- Directly enter the path for the folder in the NDS tree or on the NetWare server.
- Select a folder on a network computer.
- Select a folder in the NDS tree or on the NetWare server.

Note

- Destinations in the destination list and registration numbers must be registered in advance in **[System Settings]**. For details, see “Registering Addresses and Users for Facsimile/Scanner Functions”, *General Settings Guide*.
- Depending on the security settings, certain destinations may not be displayed.

Selecting a destination folder from the list

1 Select the destination folder.

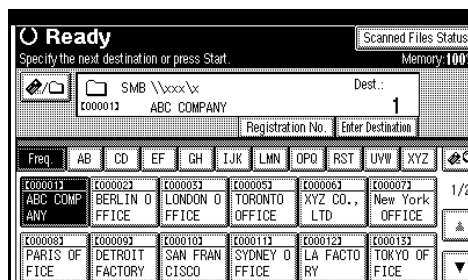

The selected folder is highlighted and also is displayed in the destination field at the top of the screen.

Note

- If the target destination does not appear, take one of the following steps:
 - Display the destination by selecting its initial letter from the title.
 - Display the destination by pressing **[▲]** or **[▼]**.
- If a protection code has been set for the shared folder, a screen for entering the protection code appears.

2 To select more destination folders, repeat step 1.

Note

- To deselect a destination, press the destination once more, or press **[▲Prev.]** or **[▼Next]** to display the destination in the destination field, and then press the **[Clear/Stop]** key.

Using a registration number to select a destination folder

- ① Press [**Registration No.**].
- ② Enter the five digit registration number that has been assigned to a destination folder using the number keys.

If the entered number is less than five digits, press the [**#**] key after the last number.

Example: To enter 00003

Press the [**3**] key, and then press the [**#**] key.

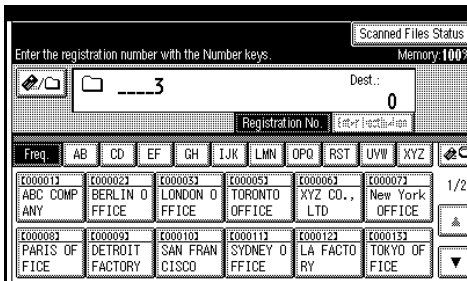

Note

- If a protection code has been set for the shared folder, a screen for entering the protection code appears.

- ③ To select more destination folders, repeat step ①~②.

Note

- To deselect a destination, press [**▲Prev.**] or [**▼Next**] to display the destination in the destination field, and then press the [**Clear/Stop**] key.

Directly enter the path for the folder of a client computer on the same network

- ① Press [**Enter Destination**].
- ② Press [**SMB**].

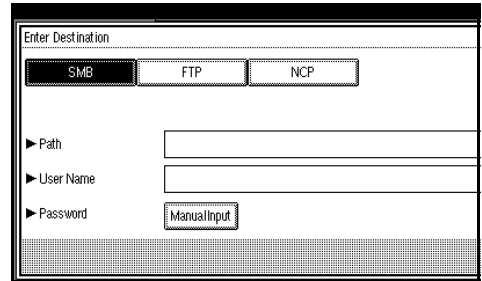

Note

- If you try to switch to a protocol from one for which [**Path**], [**User Name**] or [**Password**] is specified, a message asking you to confirm the protocol change appears.

- ③ Press [**Manual Input**] on the right side of the path field.

The soft keyboard appears.

- ④ Enter the path for the folder.

Note

- For details about the maximum number of characters that can be entered, see p.123 "Scan to Folder".
- The following is an example of a path where the folder name is "user" and the computer name is "desk01":
\\desk01\user
- An IP address can also be entered if you use one of the following operating systems : Windows 98/Me/XP/2000, Windows NT 4.0 or Windows Server 2003.

- Computer and shared folder names consisting of more than 12 characters cannot be displayed.

- 5 Press [OK].
- 6 Enter the user name according to the setting at the destination.

Press [Manual Input] to the right of the user name field to display the soft keyboard.

 **Reference**

For details about the maximum number of characters that can be entered, see p.123 "Scan to Folder".

- 7 Enter the password according to the setting at the destination.

Press [Manual Input] for [Password] to display the soft keyboard.

- 8 Press [Connection Test].

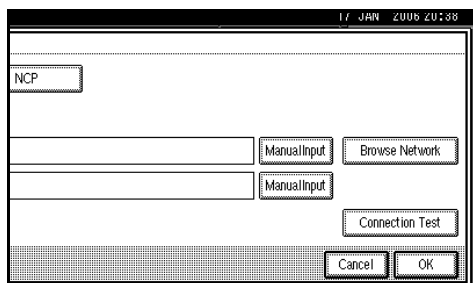

A connection test is performed to check whether the specified shared folder exists.

 **Note**

- The connection test may take time.
- You may not be able to press [Connection Test] right after pressing [Cancel] during a connection test.

- Though the connection test was successful, the machine may fail to transfer the file if writing authority is lacking or if there is not enough free space on the hard disk.

- 9 Check the connection test result, and then press [Exit].
- 10 Press [OK].
- 11 To enter more destinations, repeat steps 1 to 10.

 **Note**

- To deselect a destination, press [▲Prev.] or [▼Next] to display the destination in the destination field, and then press the [Clear/Stop] key.
- To change the path for the folder that has been entered, press [Change] on the left side of the destination field. Enter the correct path for the folder, and then press [OK].
- To check the selected destinations, press the [Check Modes] key.

Directly enter the path for the folder on the FTP server

- 1 Press [Enter Destination].
- 2 Press [FTP].

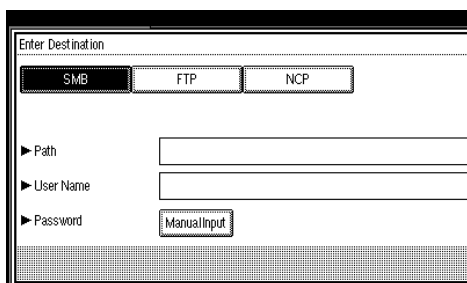

Note

- If you try to switch to a protocol from one for which **[Path]**, **[User Name]** or **[Password]** is specified, a message asking you to confirm the protocol change appears.

- 3 Press **[Manual Input]** on the right side of the server name field.

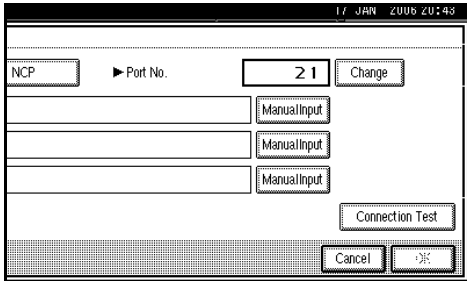

The soft keyboard appears.

- 4 Enter a server name.

Note

- For details about the maximum number of characters that can be entered, see p.123 "Scan to Folder".
- An IP address also can be entered.

- 5 Press **[OK]**.

- 6 Press **[Manual Input]** on the right side of the path field.

The soft keyboard appears.

- 7 Enter the path for the folder.

Note

- For details about the maximum number of characters that can be entered, see p.123 "Scan to Folder".
- The following is an example of a path where the folder name is "user" and the sub-folder name is "lib": user\lib

- 8 Press **[OK]**.

- 9 Enter the user name according to the setting at the destination.

Press **[Manual Input]** to the right of the user name field to display the soft keyboard.

Reference

For details about the maximum number of characters that can be entered, see p.123 "Scan to Folder".

- 10 Enter the password according to the setting at the destination.

Press **[Manual Input]** for **[Password]** to display the soft keyboard.

- 11 To change the port number which is set in **[System Settings]**, press **[Change]** on the right side of the port number field. Enter a port number using the number keys, and then press the **[#]**key.

- 12 Press **[Connection Test]**.

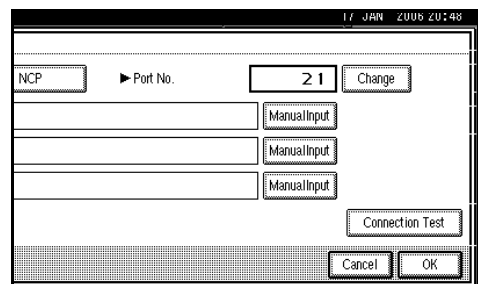

A connection test is performed to check whether the specified shared folder exists.

Note

- The connection test may take time.
- You may not be able to press **[Connection Test]** right after pressing **[Cancel]** during a connection test.

- 13 Check the connection test result, and then press [Exit].
- 14 Press [OK].
- 15 To enter more destinations, repeat steps 1 to 14.

Note

- To deselect a destination, press [▲Prev.] or [▼Next] to display the destination in the destination field, and then press the [Clear/Stop] key.
- To change the path for the folder that has been entered, press [Change] on the left side of the destination field. Enter the correct path for the folder, and then press [OK].
- To check the selected destinations, press the [Check Modes] key.

Directly enter the path for the folder in the NDS tree or on the NetWare server

- 1 Press [Enter Destination].
- 2 Press [NCP].

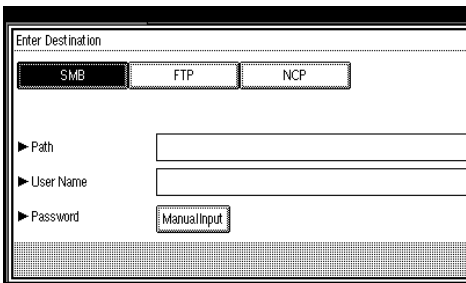

Note

- If you try to switch to a protocol from one for which [Path], [User Name] or [Password] is specified, a message asking you to confirm the protocol change appears.

- 3 Select "Connection Type". To specify the NDS tree name, press [NDS]. To specify the NetWare server name, press [Bindery].

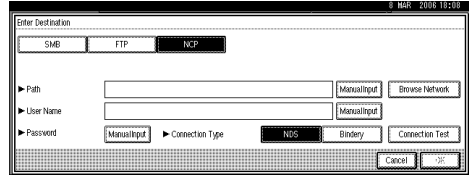

- 4 Press [Manual Input] on the right side of the path field. The soft keyboard appears.
- 5 Enter the path for the folder.

Note

- If you set "Connection Type" to [NDS], the NDS tree name is "tree", the name of the context including the volume is "context", the volume name is "volume", and the folder name is "folder", the path will be "\\tree\volume.context\folder".
- If you set "Connection Type" to [Bindery], the NetWare server name is "server", the volume name is "volume", and the folder name is "folder", the path will be "\\server\volume\folder".
- For details about the maximum number of characters that can be entered, see p.123 "Scan to Folder".

- 6 Press [OK].
- 7 Enter the user name for logging on to the NDS tree or NetWare server.

Press [Manual Input] to the right of the user name field.

The soft keyboard appears.

Note

- ❑ If you press **[NDS]** for "Connection Type", enter the user name, and then enter the name of the context containing the user object. If the user name is "user" and the name of the Context is "context", the user name will be "user.context".

Reference

For details about the maximum number of characters that can be entered, see p.123 "Scan to Folder".

8 If a password is required for logging on, enter it.

Press **[Manual Input]** to the right of the password field.

The soft keyboard appears.

9 Press [Connection Test].

A connection test checks the specified shared folder exists.

Note

- ❑ You cannot connect to folders you are not allowed to read.
 - ❑ The connection test may take time.
 - ❑ You may not be able to press **[Connection Test]** right after pressing **[Cancel]** during a connection test.
 - ❑ Even if the connection test was successful, the machine may fail to transfer the file if you do not have write privileges for the file or there is not enough free hard disk space.
- 10 Check the connection test result, and then press [Exit].**
- 11 Press [OK].**

12 To enter more destinations, repeat steps 1 to 11.**Note**

- ❑ To deselect a destination, press **[▲Prev.]** or **[▼Next]** until the destination appears in the destination field, and then press the **[Clear/Stop]** key.
- ❑ To change the path for an entered folder, press **[Change]** on the left side of the destination field. Enter the correct path for the folder, and then press **[OK]**.
- ❑ To check the selected destinations, press the **[Check-Modes]** key.

Select a folder on a network computer

1 Press [Enter Destination].**2 Press [SMB].**

The screenshot shows a dialog box titled "Enter Destination". At the top, there are three buttons: "SMB", "FTP", and "NCP". The "SMB" button is highlighted with a dark background. Below these buttons are three input fields: "Path", "User Name", and "Password". To the right of the "Password" field, there is a button labeled "Manual Input".

Note

- ❑ If you try to switch to a protocol from one for which **[Path]**, **[User Name]** or **[Password]** is specified, a message asking you to confirm the protocol change appears.
- 3 Press [Browse Network] on the right side of the path field.**
- The list of client computers on the same network appears.

Note

- Computer and shared folder names consisting of more than 12 characters cannot be displayed.
- If the client computer you want to select is not displayed, press **[Up One Level]** and then search for the client computer.
- The maximum number of client computers and shared folders that can be displayed is 100.

4 Select the client computer that has the destination folder.

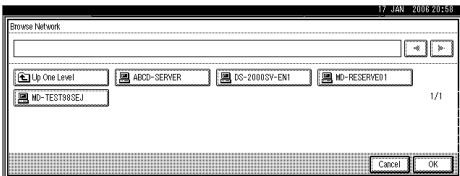

Note

- If authentication is required for the selected computer, a log-on screen appears. Enter the user name and password.

The list of folders on the selected computer appears.

5 Select the destination folder.

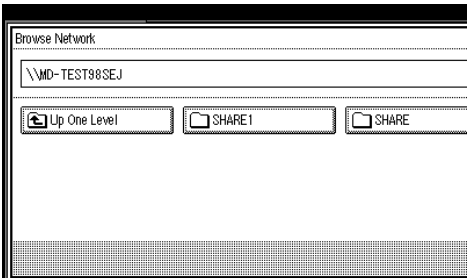

Note

- When the selected folder has sub-folders, the sub-folders list appears.
- If you cannot find the destination folder, press **[Up One Level]** and then search for the folder at that level.
- If authentication is required for the selected folder, a log-on screen appears. Enter the user name and password.
- The machine may fail to transfer the file if writing authority is lacking or if there is not enough free space on the hard disk.

6 Press [OK].

7 Press [OK].

Selecting a destination folder in an NDS tree or on a NetWare server

1 Press [Enter Destination].

2 Press [NCP].

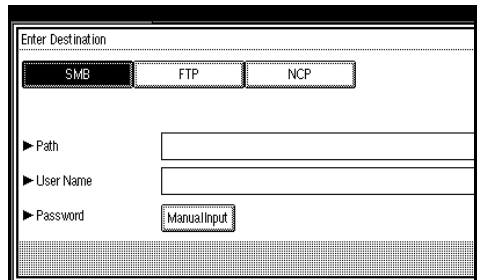

Note

- If you try to switch to a protocol from one for which **[Path]**, **[User Name]** or **[Password]** is specified, a message asking you to confirm the protocol change appears.

- 3 Select "Connection Type". To view the NDS tree, click [NDS]. To view the NetWare server, click [Bindery].

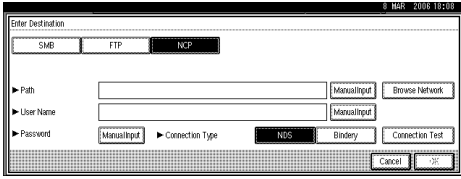

- 4 Press [Browse Network] to the right of the path name field.

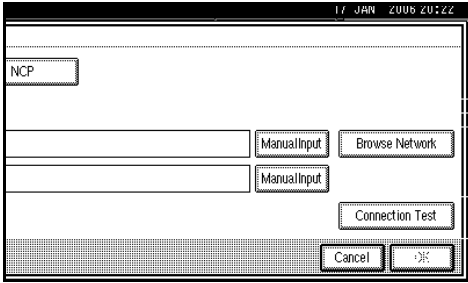

If you set "Connection Type" to [NDS], the NDS tree list appears.

If you set "Connection Type" to [Bindery], the NetWare server list appears.

Note

- ❑ Folders for which you do not have access privileges do not appear.
- ❑ If the languages used on the machine and the destination you want to view differ, items in the list may not appear correctly.
- ❑ Up to 100 items can be displayed in the list.

- 5 Search for the destination folder in the NDS tree or NetWare server.

Note

- ❑ If the selected NDS tree or NetWare server requires authentication, a login screen appears. Enter a user name and password for logging on to the NDS tree or NetWare server. If you press [NDS] for "Connection Type", enter a user name, and then enter the name of the context containing the user object. If the user name is "user" and the name of the Context is "context", the user name will be "user.context".
- ❑ If you cannot find the destination folder, press [Up One Level] and search for the folder at that level.

- 6 Select the destination folder.

Note

- ❑ If you do not have write privileges for the destination folder, or there is not enough available storage on the destination computer disk, the file may not be sent.

- 7 Press [OK].

- 8 Press [OK].

Searching for a destination folder in the destination list

- 1 Press [F3].

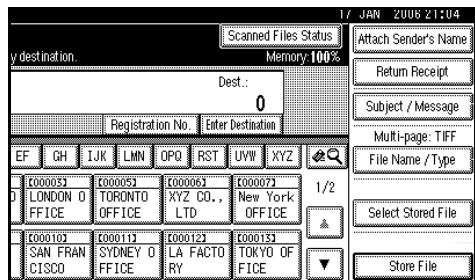

2 Press [Search by Dest. Name].

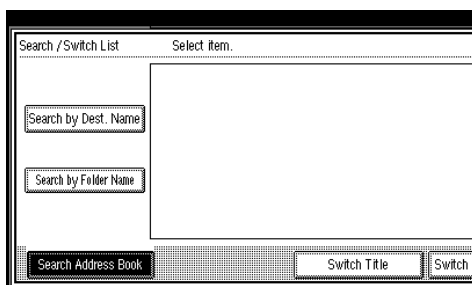

The soft keyboard appears.

Note

- To search by path, press [Search by Folder Name].

3 Enter part of the destination folder name.

Note

- Enter the first character or characters of the destination folder name or path.
- To search by path, if the destination folder path is "\\volume\user\folder", then enter "\\volume\user\f".
- It is also possible to perform a combined search using [Search by Dest. Name] and [Search by Folder Name].

4 Press [OK].

5 Select a destination folder.

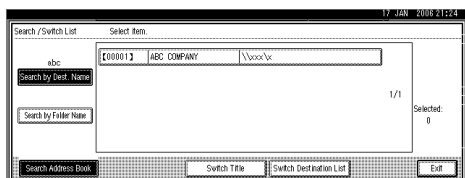

6 Press [Exit].

Checking selected destinations

1 Use the destination field at the top of the screen to check which destinations are selected.

Note

- Press [▲Prev.] or [▼Next] to scroll through the list. Destinations are displayed in the order they were selected.
- To check the selected destinations, press the [Check Modes] key.

8 Select the file type if necessary.

- 1** Press [File Name / Type].
- 2** Press [File Type].
- 3** Select the file type.

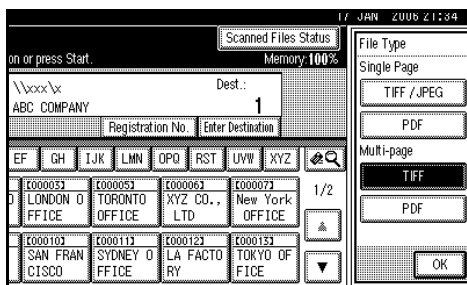

4 Press [OK] twice.

9 Specify the file name if necessary.

- 1** Press [File Name / Type].
- 2** Press [File Name].

The soft keyboard appears.

3 Enter a file name.

Note

- A scan file is given a 21-digit (excluding the extension) file name which combines the time and date the original was scanned with a 4-digit page number. (Example : When one page is scanned in TIFF at 15.10 seconds, 3.30 p.m., 31 December, 2020, the file name is 202012311530150100001.tif)

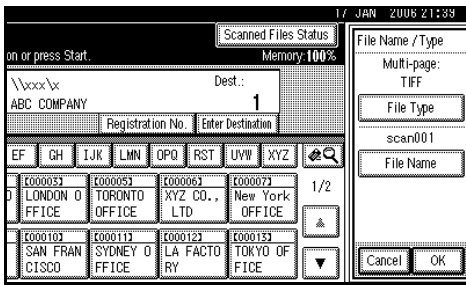
4 Press [OK].**5** Press [OK].**10** Press the [Start] key.**Note**

- For details about the maximum size of the scan file that can be sent, see p.123 “Scan to Folder”.
- To interrupt scanning, press the [Clear/Stop] key or press [Stop] on the display panel.
- When placing multiple originals one-by-one, place the next original. For details, see p.82 “Scanning Originals in Several Times”.

Simultaneous Storage and Sending by Scan to Folder

You can use the Scan to Folder function and the storage function together.

The scan file is sent by Scan to Folder and at the same time is stored.

Note

- This section explains mainly the procedure for simultaneous storage and sending by Scan to Folder. For details, see p.33 “Procedure for Sending by Scan to Folder”.

- The file stored when simultaneously storing a file and sending it by Scan to Folder cannot be resent from the Scan to Folder screen. To resend the file, select the file in the [Select Stored File] screen and send it. See p.54 “Sending Stored Files by E-mail or Scan to Folder, or Delivering”.

1 Place originals.**Note**

- The procedure for placing originals is the same as that for placing originals for copying. For details about placing originals, see “Placing Originals”, *Copy Reference*.

2 Make settings for original orientation, the sides scanned, and other settings if necessary.**Reference**

p.79 “Making the Settings Related to the Orientation of the Original and Scanned Sides”

3 Make the scan settings.**Note**

- There are two ways to specify scan settings, as described below:
 - Configure each setting for scanning. For details, see p.77 “Specifying Scan Settings”.
 - Recall registered settings. For details, see p.86 “Recalling a Program”.

4 Select the destination.**5** Specify the sender, subject, and message when sending e-mail is performed at the same time.

6 Press [Store File].

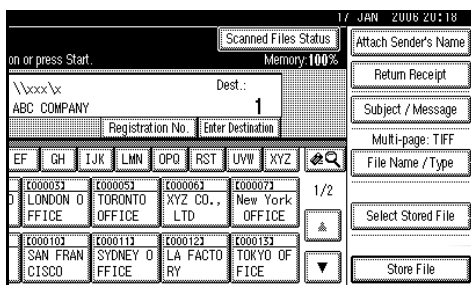

3 **7** Make sure that [Send & Store] is selected.

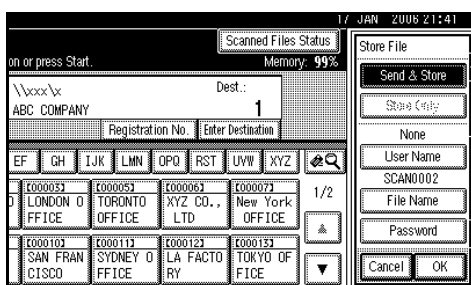

8 Specify file information if necessary.

Reference

For details about specifying file information, see p.49 “Specifying file information”.

9 Press [OK].

10 Press the [Start] key.

Checking the Scan to Folder Results

The sending results can be checked.

Note

- For details about the maximum number of sending operations that can be checked, see p.111 "Print & Delete Scanner Journal".

Items that can be checked

- Date / Time**
The date and time sending was requested or the date and time "Done", "Error" or "Cancelled" is confirmed is displayed.
- Destination**
The sending function (e-mail, Scan to Folder, or delivery function) used is displayed with an icon.
When multiple destinations were selected, the destinations are displayed individually.
- Sender**
- File Name**
The file name is displayed only when a file is stored at the same time and when a stored file is sent.
- Status**
One of the following status is displayed: "Done", "Sending...", "Waiting...", "Error", or "Cancelled".

- Press [**Scanned Files Status**] on the Scan to Folder screen.

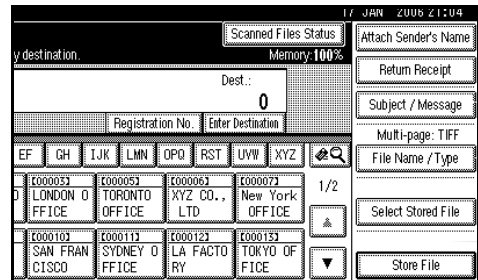

- Check the displayed records.

Date/Time	Destination	Sender	File Name	Status
17 Jan. 1962	ABC COMPANY	Jones	SCAN	Cancelled
17 Jan. 1962	BERLIN OFFICE	Jones	SCAN	Done
17 Jan. 1961	ABC COMPANY	SCAN	SCAN	Cancelled
17 Jan. 1859	ABC COMPANY	BERLIN OFFICE	Cancelled	Cancelled
17 Jan. 1855	All ten	Berlin	Done	Done

Note

- Depending on the security settings, certain records may not be displayed.
- One screen shows the records for five sending operations. Press [**▲Prev.**] or [**▼Next**] to scroll through the screen.
- When the status of a file is "Waiting...", the sending can be canceled by selecting that file, and then pressing [**Cancel**].
- Press [**Print**] to print the whole journal.

- Press [**Exit**].

The Scan to Folder screen appears.

4. Storing Files

Scan files can be stored in the hard disk of the machine using the Document Server function, and the stored file can be used later. Using DeskTopBinder, stored files can be viewed or retrieved with a client computer.

Important

- A password can be set for every stored file. There is a risk that stored files without a password can be accessed by someone using DeskTopBinder on the same LAN. We recommend you consider security measures such as setting passwords to protect against unauthorized access.
- Scan file stored in the machine may be lost if some kind of failure occurs. We advise against using the hard disk to store important files. The supplier shall not be responsible for any damage that may result from the loss of files. For long-term storage of files, we recommend the use of DeskTopBinder. For details, contact your local dealer.

Note

- When a delivery server is added to the network, stored files can be delivered. You can store scan files and simultaneously deliver them with the network delivery scanner function, send it by e-mail, or send it by Scan to Folder. See p.54 “Sending Stored Files by E-mail or Scan to Folder, or Delivering”.

Storing Files

This section explains how to store files and how to specify file information for stored files.

Note

- For details about the maximum number of files that can be stored, see p.124 “Store”.
- The stored files are deleted automatically after a certain number of days have passed. For information about making settings and changing settings, see *General Settings Guide*.
- Files cannot be printed from the control panel after being stored using the scanner function. Print scan files after a client computer receives them. See p.56 “Viewing a list of stored files using DeskTopBinder” or p.56 “Viewing a list of stored files using Web Image Monitor”.

Storage Procedure

You can scan and store files.

1 Press the **[Scanner]** key.

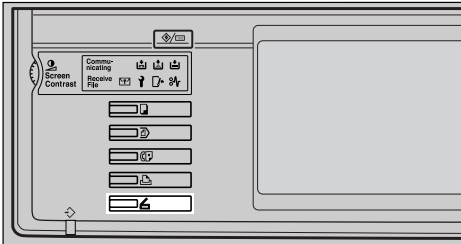

ZZZ607S

4

Note

The illustration is an example. The actual appearance may be different.

2 Make sure that no previous settings remain.

Note

If a previous setting remains, press the **[Clear Modes]** key.

3 Place originals.

Reference

The procedure for placing originals is the same as that for placing originals for copying. For details about placing originals, see “Placing Originals”, *Copy Reference*.

4 Make settings for original orientation, the sides scanned, and other settings if necessary.

Reference

p.79 “Making the Settings Related to the Orientation of the Original and Scanned Sides”

5 Make the scan settings.

Reference

There are two ways to specify scan settings, as described below:

- Configure each setting for scanning. For details, see p.77 “Specifying Scan Settings”.
- Recall registered settings. For details, see p.86 “Recalling a Program”.

6 Make the settings for storing scan files.

1 Press **[Store File]**.

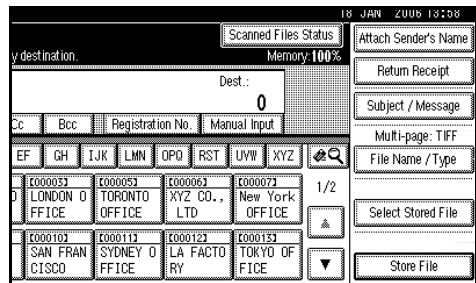

2 Press **[Store Only]**.

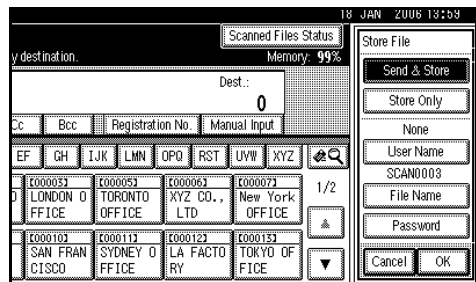

Note

To store and deliver scan files, press **[Send & Store]**. See p.27 “Simultaneous Storage and Sending by E-mail”, p.43 “Simultaneous Storage and Sending by Scan to Folder”, or p.69 “Simultaneous Storage and Delivery”.

[Store Only] cannot be pressed if a destination or sender is selected.

3 Press **[OK]**.

7 Specify file information.

Specify a user name, file name, and password for the file.

Reference

For details about specifying file information, see p.49 “Specifying file information”.

8 Press the [Start] key.

Note

- To interrupt scanning, press the [Clear/Stop] key or press [Stop] on the display panel.
- When placing multiple originals one-by-one, place the next original. For details, see p.82 “Scanning Originals in Several Times”.

9 Press [Store File].

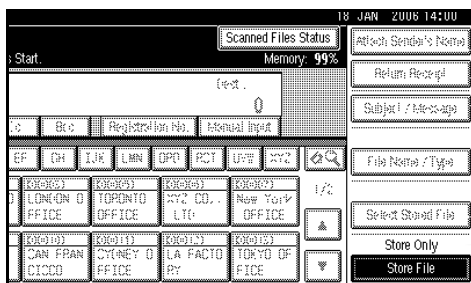

10 Press [Cancel].

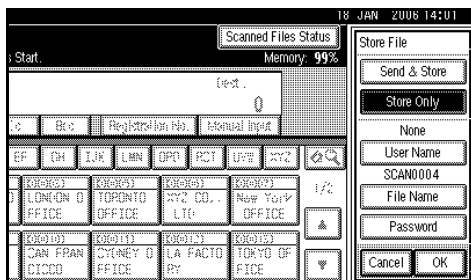

Specifying file information

You can specify a user name, file name, and password for a stored scan file.

According to the settings made, you can search for files by user name or file name and you can prevent unauthorized persons from accessing the files.

Reference

For details about the maximum number of characters that can be entered, see p.124 “Store”.

1 Press [Store File].

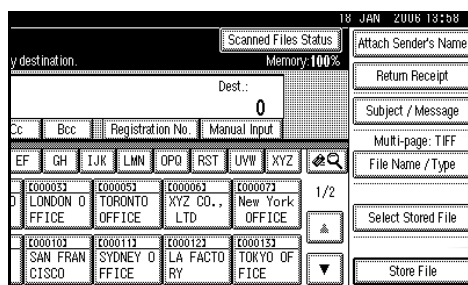

The File Information screen appears.

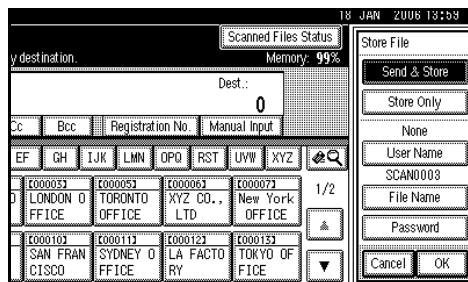

2 Specify file information.

Specifying a user name

- 1 Press [User Name].
- 2 Select the user name.

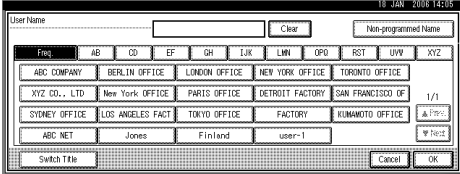

Note

- The user names shown here are names that were registered on the [Administrator Tools] tab in [System Settings]. To specify a name not shown here, press [Non-programmed Name], and then enter the user name.

- 3 Press [OK].

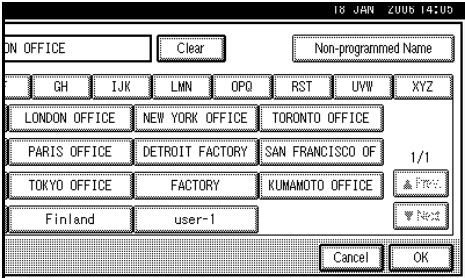

Specifying a file name

Scan files are automatically named SCAN0001, SCAN0002, etc. If necessary, you can change the file name.

- 1 Press [File Name].
The soft keyboard appears.
- 2 Enter the file name.

Reference

For information about how to enter characters, see *General Settings Guide*.

- 3 Press [OK].

Specifying a password

When a password is specified, only a person who knows the password can view the file.

- 1 Press [Password].
- 2 Enter a four to eight digit number using the number keys.

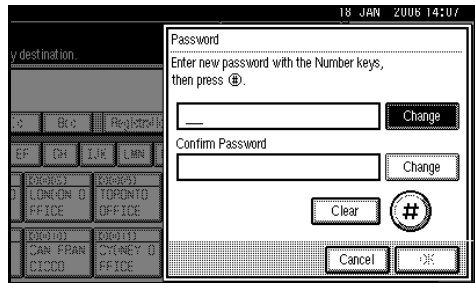

- 3 Press the [#] key.

Note

- To change the password, press [Change], and then enter a new one.

- 4 Enter the same number as you entered in step 2 for confirmation.
- 5 Press the [#] key.
- 6 Press [OK].

Important

- Do not forget the password. If you forget it, consult the system administrator of the machine.

- 3 Press [OK] to return to the previous screen.

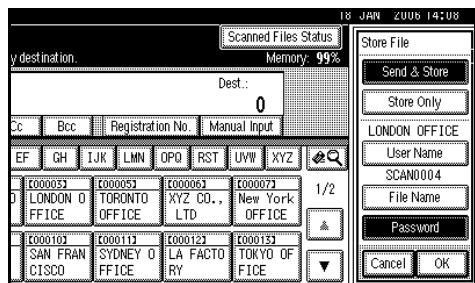

Displaying the List of Stored Files

From the list of stored files, you can delete stored files or change file information. To show the list of stored files, perform the following steps:

Note

- You can also display the list of stored files from a client computer using DeskTopBinder and Web Image Monitor. For details, see p.55 “Checking Stored Files from a Client Computer”.

1 Press the [Scanner] key.

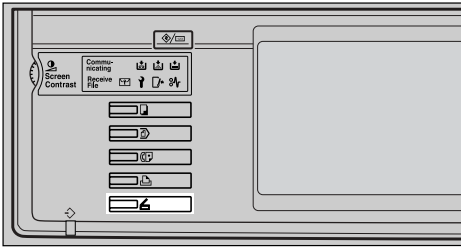

ZZZ607S

Note

- The illustration is an example. The actual appearance may be different.

2 Press [Select Stored File].

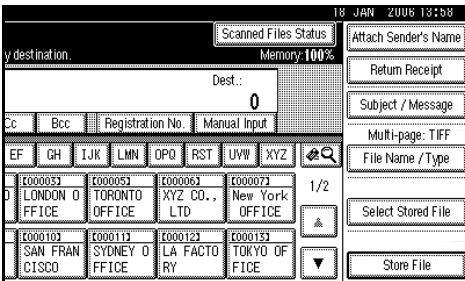

Viewing the List

The list of stored files has the following elements.

The function items displayed serve as selector keys. You can select or specify an item by lightly pressing it. When you select or specify an item on the display panel, it is highlighted like **Full Size**. Keys that cannot be selected appear like **OK**.

 **Note**

□ Depending on the security settings, certain files may not be displayed.

❖ **When displaying information on all stored files**

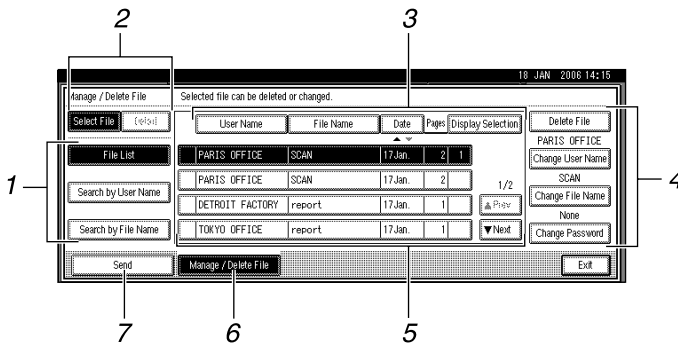

❖ **When displaying information of a selected stored file**

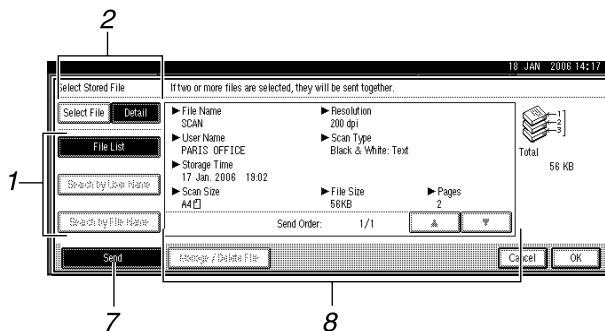

1. Keys for searching for files

Press to switch to the screens for searching for a file by user name or file name, or to the screen for displaying all files.

2. Keys to switch to the information display

Press to switch between the stored file list and the detailed information of the selected file.

3. Keys for sorting files

Press to sort the files using the selected item. Select the same item once more for a reverse sort. However, the files cannot be sorted in reverse delivery order.

4. Keys for changing file information

Use for deleting the selected file or changing the user name, file name, or password.

5. List of stored files

Displays the list of stored files.

Note

- The files that are stored by functions other than the scanner can be displayed by pressing the **[Document Server]** key.
- If the file is not displayed, press **[▲Prev.]** or **[▼Next]** to scroll through the list.
- For files which are password protected, a key symbol(Ⓚ) is shown to the left of the user name.

6. [Manage / Delete File]

Press to perform operations such as deleting stored files or changing file information.

7. [Send]

Press to send or deliver stored files. For details, see p.54 “Sending Stored Files by E-mail or Scan to Folder, or Delivering”.

8. Information for a selected stored file

Press **[Detail]** to display the information for a file after selecting the file from the file list.

Searching for Files

You can search for files from the stored files using the user name or file name.

Searching by user name

- 1** On the screen with the list of stored files, press **[Search by User Name]**.
- 2** Select the user name to be used for the search.

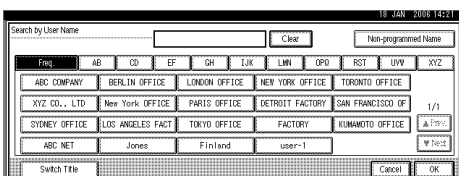

Note

- The user names shown here are names that were registered on the **[Administrator Tools]** tab in **[System Settings]**. To change a user name not shown here, press **[Non-programmed Name]**, and then enter the user name.

3 Press [OK].

The search starts, and files whose user name starts with the entered string appear.

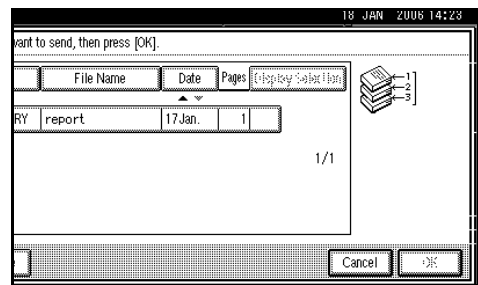

4

Searching by file name

- 1** On the screen with the list of stored files, press **[Search by File Name]**.
The soft keyboard appears.
- 2** Enter the file name.

Note

- It is necessary to differentiate between uppercase and lowercase letters.

Reference

For information about how to enter characters, see *General Settings Guide*.

3 Press [OK].

The search starts, and files whose name starts with the entered string appear.

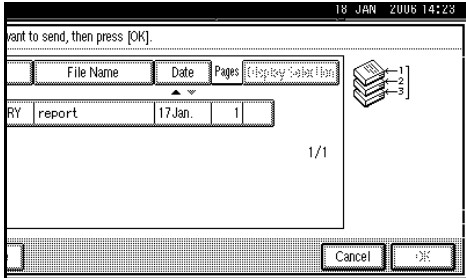

4

Sending Stored Files by E-mail or Scan to Folder, or Delivering

Files stored can be sent by e-mail or Scan to Folder, or delivered to the delivery server.

Note

- This section explains how to select files you want to send or deliver. For details about sending by e-mail, see p.17 “Procedure for Sending E-mail”. For details about sending by Scan to Folder, see p.33 “Procedure for Sending by Scan to Folder”. For details about delivering stored files, see p.64 “Delivering Scan Files”.
- When stored files are sent or delivered, scan settings cannot be changed. The files are sent or delivered with the scan settings specified when they were stored.

1 Press [Select Stored File] to display the list of stored files.**Reference**

p.51 “Displaying the List of Stored Files”

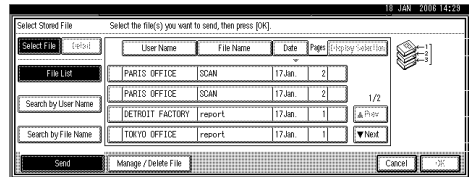
2 Select a file.**Note**

- When you select a password protected file, the Password entry screen appears. After you have entered the correct password and pressed [OK], the file will be selected.

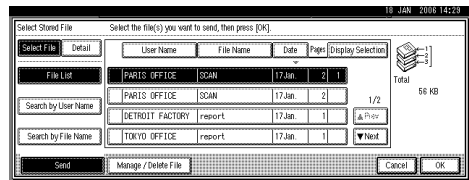
3 To select multiple files, repeat step 2.**Note**

- For details about the maximum number of files that can be selected at once, see p.124 “Store”.
- If you select multiple files, the files will be sent or delivered in the order they were selected.
- If you press [Display Selection], the selected files will be shown in the order of delivery.

4 Press [OK].

The e-mail, Scan to Folder, or network delivery scanner screen appears.

5 Switch the destination list if necessary.**6** Specify a destination.**7** Specify the sender, subject, and message if necessary.**8** Press the [Start] key.

9 Press [Select Stored File].

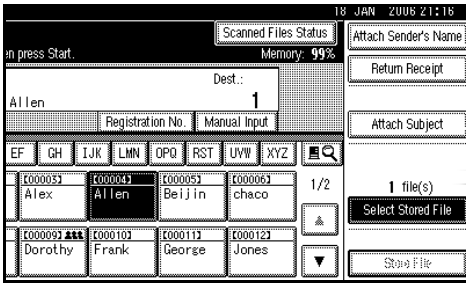

10 Press [Cancel].

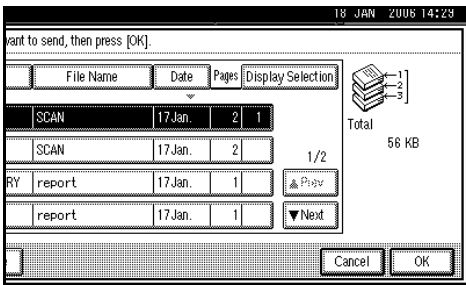

Sending URL addresses of stored files by e-mail

Using this setting, you can e-mail only URL addresses of stored file locations, instead of attaching the files to the e-mail. Transmitted URL addresses allow a stored file to be viewed, deleted, or downloaded over the network using Web Image Monitor. This is useful if you cannot attach files to the e-mail due to network restrictions.

Note

- Settings for the above functions must be made in advance in [Scanner Features]. See p.112 “Stored File E-mail Method”.
- For details about transmission procedure, see p.54 “Sending Stored Files by E-mail or Scan to Folder, or Delivering”.
- You can send URL addresses by e-mail and files by Scan to Folder simultaneously.

Below is a sample e-mail received at the destination when sending the URL address by e-mail.

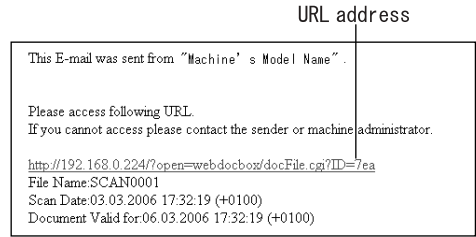

If you click the transmitted URL address, Web Image Monitor opens to enable viewing, deleting, and downloading over the network of the file stored at the location.

Note

- Depending on the operating environment, clicking the transmitted URL address may not open the Web browser allowing files to be viewed.

Checking Stored Files from a Client Computer

You can view the list of stored files from a client computer using DeskTopBinder and Web Image Monitor.

Note

- You can also view the files stored under the copy, Document Server, and printer functions.
- The illustration used in the following explanation is an example. The items that actually appear on the screen may differ, depending on the model in use and the environment.

Viewing a list of stored files using DeskTopBinder

Stored files are shown below using DeskTopBinder.

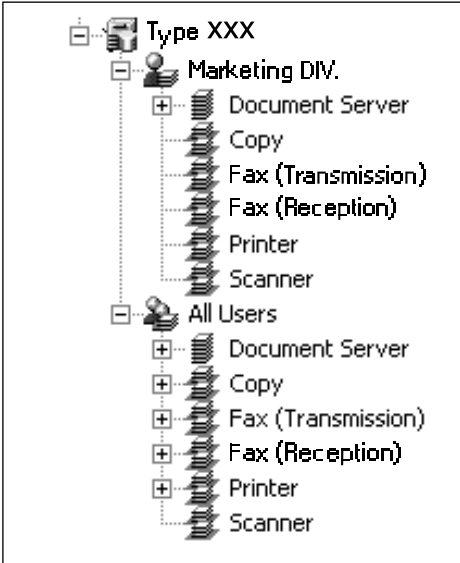

Note

- The illustration is an example. The items that actually appear may be different.
- You can also transfer the stored files to the client computer.
- We recommend using Web Image Monitor only within a local area network.

Reference

For details about installing DeskTopBinder, see p.11 “DeskTopBinder”. For details about the functions of DeskTopBinder, such as transferring files to a client computer, see the manuals related to DeskTopBinder manuals. See p.i “Manuals for This Machine”.

Viewing a list of stored files using Web Image Monitor

The stored files are displayed and can be checked also in Web Image Monitor.

Note

- When you enter http:// (machine IP address)/ in the address bar of the Web browser on a client computer, Top Page of Web Image Monitor is displayed.
- You can also download the stored files.

Reference

For details about displaying or downloading stored files using Web Image Monitor, see *General Settings Guide*.

For details about making settings for using Web Image Monitor, see *Network Guide*.

For details about functions for managing stored files using Web Image Monitor, click **[Help]** on the upper-right corner of the displayed screen.

Managing Stored Files

Deleting Files

You can delete files that are no longer needed.

Limitation

- ❑ Files waiting for delivery cannot be deleted.

Reference

Using Web Image Monitor from a client computer, you can also delete the stored files. See *General Settings Guide*.

1 Display the list of stored files.

Reference

p.51 “Displaying the List of Stored Files”

2 Press [Manage / Delete File].

The [Manage / Delete File] screen appears.

3 Select the file you want to delete.

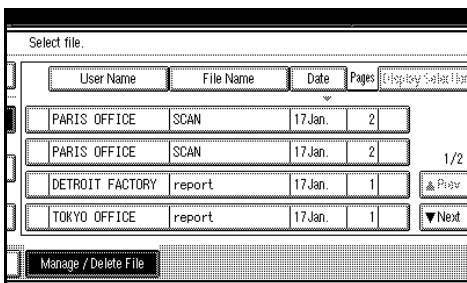

Note

- ❑ For details about the maximum number of files that can be selected at once, see p.124 “Store”.

- ❑ When you select a password protected file, the Password entry screen appears. Enter the correct password, and then press [OK]. When multiple files are selected, the password entry screen appears each time a password protected file is selected.

4 Press [Delete File].

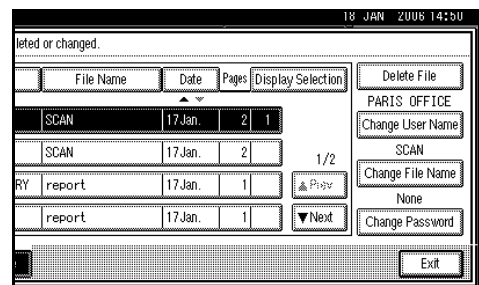

A confirmation message about deleting the file appears.

5 Press [Delete].

6 Press [Exit].

Changing File Information

The information for stored files (user name, file name, and password) can be changed.

Limitation

- ❑ Information for files waiting for delivery cannot be changed.

Reference

Using Web Image Monitor from a client computer, you can change the information of files stored. See *General Settings Guide*.

1 Display the list of stored files.

Reference

p.51 “Displaying the List of Stored Files”

2 Press [Manage / Delete File].

3 Select the file for which you want to change the file information.

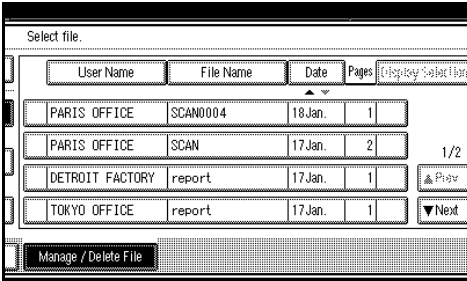

Note

When you select a password protected file, the password entry screen appears. Enter the correct password, and then press [OK].

4 Change the file information.

Changing the user name

1 Press [Change User Name].

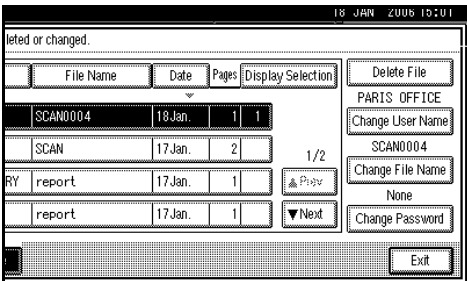

2 Select the new user name.



Note

The user names shown here are names that were registered on the [Administrator Tools] tab in [System Settings]. To change a user name not shown here, press [Non-programmed Name], and then enter the user name.

3 Press [OK].

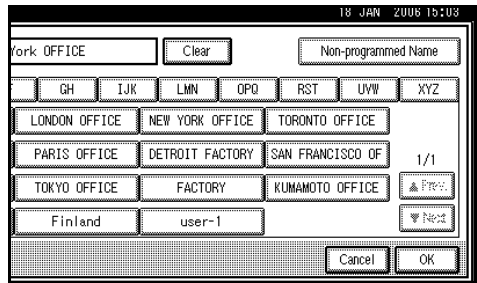

Changing the file name

1 Press [Change File Name].

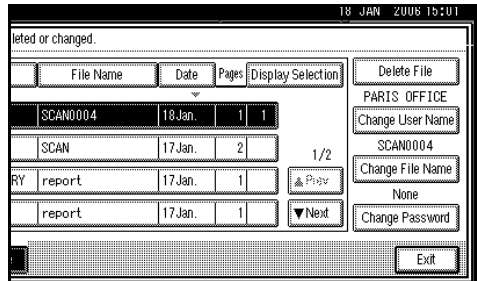

2 Enter the new file name.

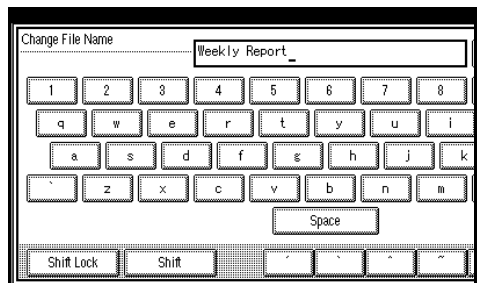

Reference

For information about how to enter characters, see *General Settings Guide*.

3 Press [OK].

Changing the password

- 1 Press [Change Password].

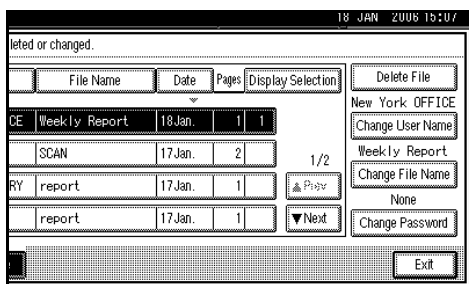

- 2 Enter a new four to eight digit number as the password using the number keys.

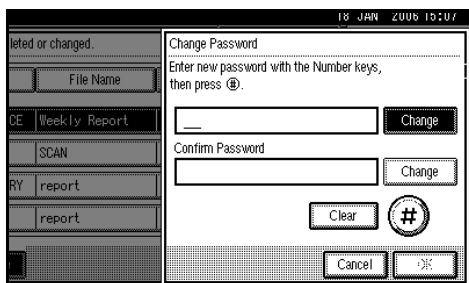

- 3 Press the [#] key.

Note

- To change the password, press [Change], and then enter a new one.
- 4 Enter the same number as you entered in step 2 for confirmation.
 - 5 Press the [#] key.
 - 6 Press [OK].

Important

- Do not forget the password. If you forget it, consult the system administrator of the machine.

- 5 Make sure that the file information was changed as necessary, and press [Exit].

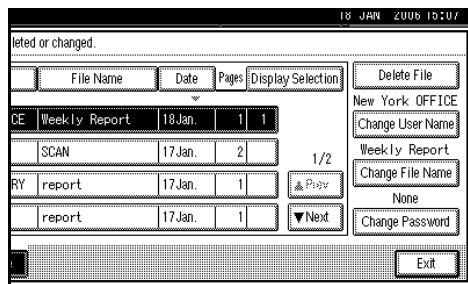

5. Delivering Scan Files

Scan files can be sent to a specified destination using the network delivery scanner function. This chapter explains the preparation for delivering files, various display screens, delivery procedures, and how to check the delivery results when this function is used.

Important

- A delivery server in which the ScanRouter delivery software is installed is necessary to use the network delivery scanner function. Information about delivery destinations and senders must be registered first in the delivery server. Also, connected devices should be configured in **[Set I/O Device]** of the ScanRouter delivery software. For details, see the ScanRouter delivery software Help.

Preparation for Delivering

To use the machine as a network delivery scanner, the preparation described below is required.

1 Connect to Network

Connect the machine to the network with an Ethernet cable or IEEE 1394 cable, or use wireless LAN.

To connect using an IEEE 1394 cable, the IEEE 1394 interface board is required. To connect using wireless LAN, the IEEE 802.11b interface unit is required.

See *Network Guide*.

2 Make System Settings

To deliver scan files, the following **[System Settings]** settings must be specified correctly. (Certain other settings must also be specified.)

- IP address
- subnet mask

Also, **[On]** must be selected for **[Delivery Option]** under **[File Transfer]**. For details about making settings and other settings, see "Connecting and Setting Up" "*Network Guide*".

3 Make Scanner Settings

Make settings for the network delivery scanner function, such as Scan Settings..

See p.101 "Initial Scanner Setup".

4 Install Delivery Software

Install the ScanRouter delivery software required for using the network delivery scanner functions on the delivery server.

After installing the software, make the required settings for server maintenance and delivery service.

For details, see the ScanRouter delivery software manuals.

5 Set Destination, Sender Information, and connected devices

Set the destination, sender information, and connected devices in the ScanRouter delivery software.

6 Install Client Computer Software

On the client computers, install the software required for viewing or retrieving files by connecting to the delivery server, such as DeskTopBinder.

See p.11 "DeskTopBinder".

Network Delivery Scanner Screen

The network delivery scanner screen is as shown.

The function items displayed serve as selector keys. You can select or specify an item by lightly pressing it. When you select or specify an item on the display panel, it is highlighted like **Full Size**. Keys that cannot be selected appear like **OK**.

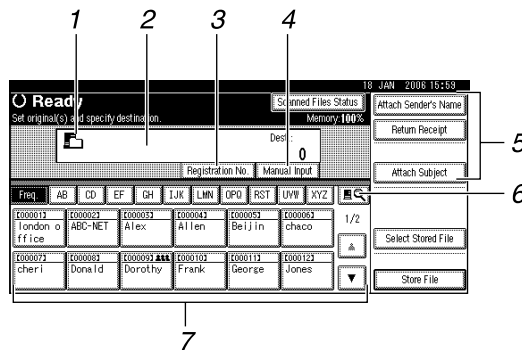

1. Network delivery scanner icon (🖨️)

Indicates that the network delivery scanner screen is displayed.

2. Destination field

The selected destination is shown here. If multiple destinations are selected, the destinations are displayed in the order they were selected by pressing [**▲Prev.**] or [**▼Next**].

Note

- To check the selected destinations, press the [**Check Modes**] key.

3. [Registration No.]

Press to specify a destination using a five digit registration number.

4. [Manual Input]

When sending e-mail via the delivery server, press [**Manual Input**], and then enter the destination using the soft keyboard that is displayed. For information about sending e-mail via the delivery server, see the ScanRouter delivery software manuals.

5. [Attach Sender's Name] [Return Receipt] [Attach Subject]

Specify the sender, subject, and message of the document to be delivered. In addition, specify whether or not to check whether the file has been opened at the destination.

6. [] Switch Destination List/Search

Press to switch a destination list of this machine to a destination in the delivery server list, to search for a destination.

7. Destination list

Displays the destinations registered in the delivery server or this machine.

Note

- When the entire list does not fit on one screen, press [**▲**] or [**▼**] to scroll through the list.
- Group destinations are denoted by this symbol (###).

Delivering Scan Files

Delivery Procedure

A scan file is delivered after scan settings and destinations are specified. If necessary, you can select a sender and a subject.

1 Press the **[Scanner]** key.

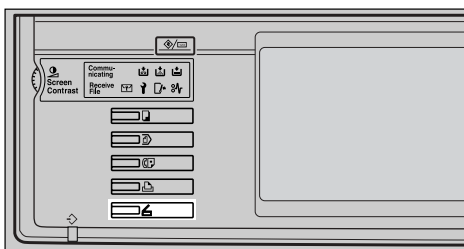

ZZZ607S

Note

- The illustration is an example. The actual appearance may be different.

2 Make sure that no previous settings remain.

Note

- If a previous setting remains, press the **[Clear Modes]** key.

3 Place originals.

Reference

The procedure for placing originals is the same as that for placing originals for copying. For details about placing originals, see "Placing Originals", *Copy Reference*.

4 Make settings for original orientation, the sides scanned, and other settings if necessary.

Reference

p.79 "Making the Settings Related to the Orientation of the Original and Scanned Sides"

5 Make the scan settings.

Reference

There are two ways to specify scan settings, as described below:

- Configure each setting for scanning. For details, see p.77 "Specifying Scan Settings".
- Recall registered settings. For details, see p.86 "Recalling a Program".

6 If the e-mail screen appears, switch to the network delivery scanner screen.

1 Press **[]**.

2 Press **[Switch Destination List]**.

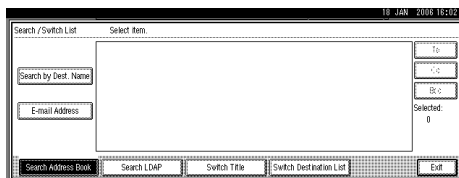

3 Press **[Delivery Server]**.

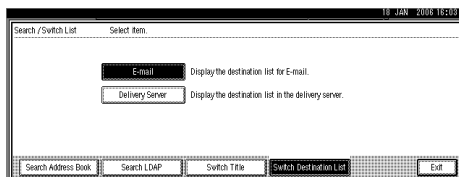

4 Press **[Exit]**.

The network delivery scanner screen appears.

7 Specify the destination.

You can specify the destination in the following ways:

- Select it from the destination list.
- Specify its registration number.
- Search for it.
- Enter the e-mail address directly.

Note

- The destination list is updated automatically.
- Depending on the security settings, certain destinations may not be displayed.

Selecting a destination from the list

1 Select the destination.

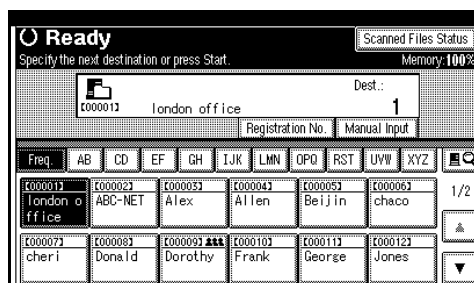

The selected destination is highlighted and also is displayed in the destination field at the top of the screen.

Note

- If the target destination does not appear, take one of the following steps:
 - Display the destination by selecting its initial letter from the title.
 - Display the destination by pressing [**▲**] or [**▼**].
- The destination titles are programmed in the delivery server.

- To deselect a destination, press the destination once more, or press [**▲Prev.**] or [**▼Next**] to display the destination in the destination field, and then press the [**Clear/Stop**] key.

2 To select more destinations, repeat step 1.

Using a registration number to select a destination

1 Press [**Registration No.**].

2 Enter the five digit registration number that has been assigned to a destination folder using the number keys.

If the entered number is less than five digits, press the [**#**] key after the last number.

Example: To enter 00009

Press the [**9**] key, and then press the [**#**] key.

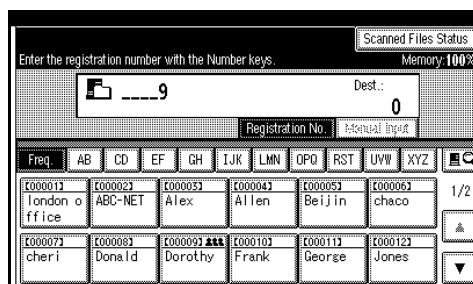

Note

- To deselect a destination, press [**▲Prev.**] or [**▼Next**] to display the destination in the destination field, and then press the [**Clear/Stop**] key.
- 3 To select more destinations, repeat step 2.**

Searching for a destination

1 Press [F4].

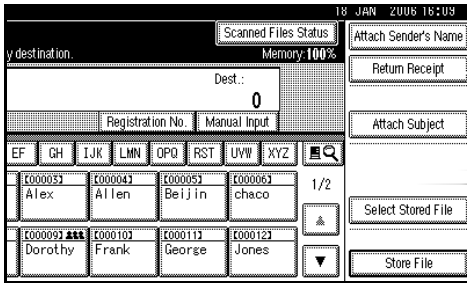

2 Press [Search Address Book].

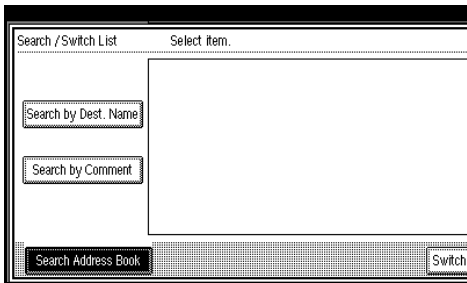

3 Press [Search by Dest. Name].

Note

- To search by comment, press [Search by Comment].

The soft keyboard appears.

4 Enter part of the destination name.

Note

- Enter the first character or characters of the destination name.

5 Press [OK].

6 Select a destination.

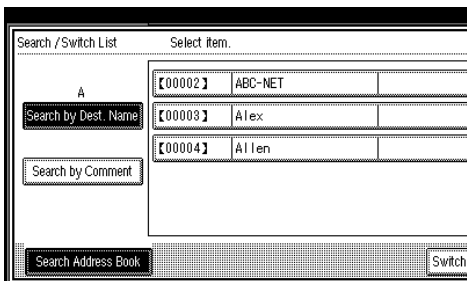

7 Press [Exit].

Manual entry of a destination

1 Press [Manual Input].

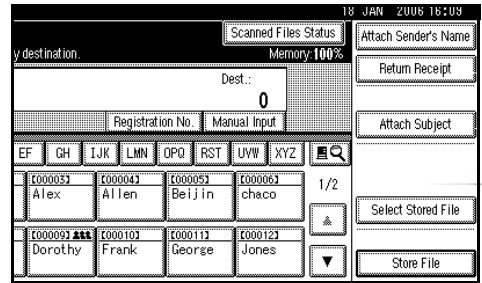

The soft keyboard appears.

2 Enter the destination.

Note

- Enter the e-mail address of the destination when sending via the delivery server.
- For details about the maximum number of characters that can be entered, see p.125 "The network delivery scanner function".
- Alphanumeric characters and periods can be entered. The symbols () \ , ; : " and spaces cannot be entered. For details, see p.125 "The network delivery scanner function".

3 Press [OK].

Note

- To deselect a destination, press [▲Prev.] or [▼Next] to display the destination in the destination field, and then press the [Clear/Stop] key.
- To check the selected destinations, press the [Check Modes] key.

4 To enter more destinations, repeat steps 1 to 3.

Checking selected destinations

- 1 Use the destination field at the top of the screen to check which destinations are selected.

Note

- Press [**▲Prev.**] or [**▼Next**] to scroll through the list. Destinations are displayed in the order they were selected.
- To check the selected destinations, press the [**Check Modes**] key.

- 8 Specify the sender (sender of the file) if necessary.

You can specify the sender in the following ways:

- Select it from the list.
- Specify its registration number.
- Search for it.

Note

- When a sender has been specified, this information is added to the scan file. Select a sender from the senders registered in the delivery server.
- Depending on the security settings, [**Attach Sender's Name**] may be selected as the user name when logging in.

Selecting a sender from the list

- 1 Press [**Attach Sender's Name**].

- 2 Select the sender.

The selected sender and its registration number appear.

- 3 Press [**OK**].

Using a registration number to specify a sender name

- 1 Press [**Attach Sender's Name**].

- 2 Enter the five digit registration number that has been assigned to a destination folder using the number keys.

If the entered number is less than five digits, press the [**#**] key after the last number.

Example: To enter 00006

Press the [**6**] key, and then press the [**#**] key.

- 3 Press [**OK**].

Searching for a sender

1 Press [Attach Sender's Name].

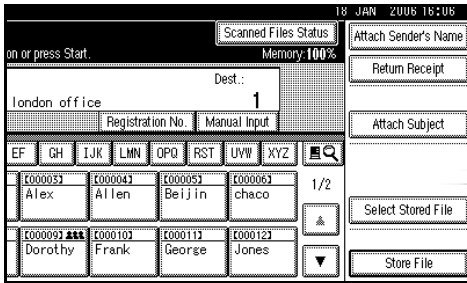

2 Press [Search].

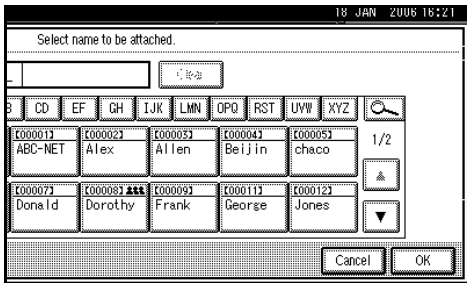

3 Press [User (Dest.) Name].

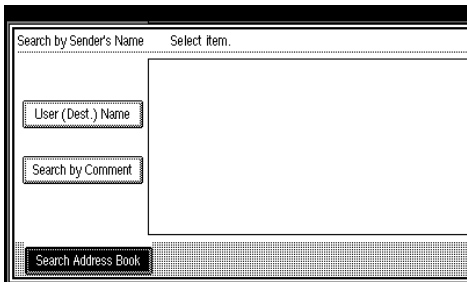

The soft keyboard appears.

4 Enter part of the sender name.

Note

- Enter the first character or characters of the sender name.

5 Press [OK].

6 Select a sender.

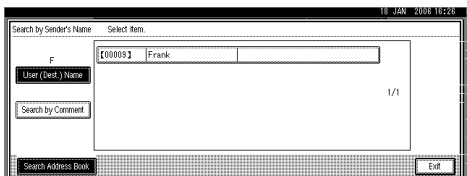

7 Press [Exit].

8 Press [OK].

9 Specify [Return Receipt] if necessary.

Note

- E-mail notifying the sender that their file has been opened at the destination is sent to the address specified in Step 3. Register the sender's e-mail address in advance using ScanRouter.
- To enable [Return Receipt], you must specify e-mail transmission via SMTP in ScanRouter.
- If the mail application used by the destination party does not support MDN (Message Disposition Notification), the e-mail may not be sent.

10 Specify a subject if necessary.

Note

- To specify a subject, you can select it from the list, enter it directly, or combine selecting and entering it.
- For details about the maximum number of characters that can be entered, see p.125 "The network delivery scanner function".
- When a subject has been specified, this information is added to the scan file.
- The subjects that can be selected from the list must be registered in [System Settings] in advance. See *Network Guide*.

The procedure to specify the subject name "[Urgent] New product appearance" is explained as an example here.

1 Press [Attach Subject].

18 JAN 2008 18:08

Scanned Files Status Memory: 100%

on or press Start.

Dest.: London office 1

Registration No. Manual Input

Attach Sender's Name

Return Receipt

Attach Subject

EF	GH	IJK	LMN	OPQ	RST	UVW	XYZ	1/2
[000053]	[000043]	[000053]	[000063]					
Alex	Allen	Beijin	chaco					
[000093]	[000103]	[000113]	[000123]					
Dorothy	Frank	George	Jones					

Select Stored File

Store File

2 Press the subject [Urgent].

Attach Subject

Manual Input

[Urgent] * None * None

[High] * None * None

* None * None * None

* None * None * None

3 Press [Manual Input].

The soft keyboard appears.

4 Enter the subject "New product appearance".**5 Press [OK] twice.****11 Press the [Start] key.****Note**

- To interrupt scanning, press the **[Clear/Stop]** key or press **[Stop]** on the display panel.
- When placing multiple originals one-by-one, place the next original. For details, see p.82 "Scanning Originals in Several Times".

Simultaneous Storage and Delivery

You can use the network delivery scanner function and the storage function together.

The scan file is delivered and at the same time is stored.

Note

- This section explains mainly the procedure for simultaneous delivery and storage. For details, see p.64 "Delivering Scan Files".

1 Place originals.**Note**

- The procedure for placing originals is the same as that for placing originals for copying. For details about placing originals, see "Placing Originals", *Copy Reference*.

2 Make settings for original orientation, the sides scanned, and other settings if necessary.**Reference**

p.79 "Making the Settings Related to the Orientation of the Original and Scanned Sides"

3 Make the scan settings.**Note**

- There are two ways to specify scan settings, as described below:
 - Configure each setting for scanning. For details, see p.77 "Specifying Scan Settings".
 - Recall registered settings. For details, see p.86 "Recalling a Program".

- 4** Select the destination.
- 5** Specify the sender and a subject if necessary.
- 6** Press [Store File].

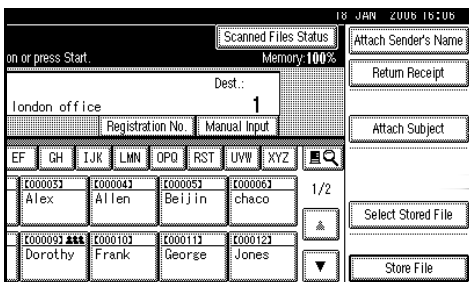

- 7** Make sure that [Send & Store] is selected.

5

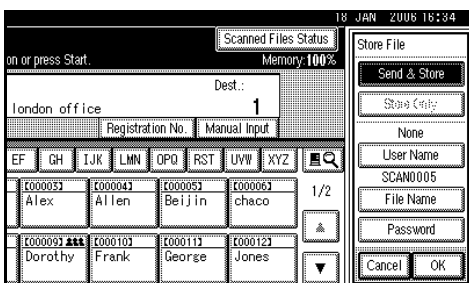

- 8** Make settings for file information if necessary.

Reference

For details about specifying file information, see p.49 “Specifying file information”.

- 9** Press [OK].
- 10** Press the [Start] key.

Checking the Status of Delivery

The sending results can be checked.

Note

- For details about the maximum number of sending operations that can be checked, see p.111 "Print & Delete Scanner Journal".

❖ Items that can be checked

- **Date / Time**
The date and time the delivery was requested or the date and time "Done", "Error" or "Cancelled" was confirmed is displayed.
- **Destination**
The sending function (e-mail, Scan to Folder, or delivery function) used is displayed with an icon.
When multiple destinations were selected, the first selected destination is displayed.
- **Sender**
- **File Name**
The file name is displayed only when a file is stored at the same time and when a stored file is sent.
- **Status**
One of the following status is displayed: "Done", "Sending...", "Waiting...", "Error", or "Cancelled".

- 1 Press **[Scanned Files Status]** on the network delivery scanner screen.

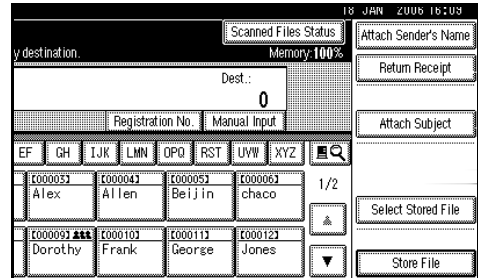

- 2 Check the displayed records.

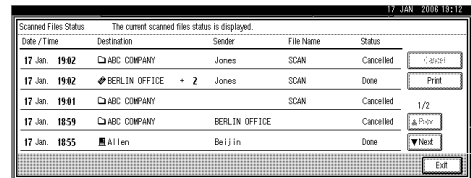

Note

- Depending on the security settings, certain records may not be displayed.
- One screen shows the records for five delivery operations. Press **[▲Prev.]** or **[▼Next]** to scroll through the screen.
- When the status of a file is "Waiting...", the delivery can be canceled by selecting that file, and then pressing **[Cancel]**.
- Press **[Print]** to print the whole journal.

- 3 Press **[Exit]**.

The network delivery scanner screen appears.

6. Using the Network TWAIN Scanner Function

This chapter explains the procedure for scanning originals with the network TWAIN scanner using DeskTopBinder. In addition, the preparation for using the network TWAIN scanner is explained.

Preparation for Using the Network TWAIN Scanner

To use the machine as a network TWAIN scanner, the preparation described below is required.

①

Connect to Network

Connect the machine to the network with an Ethernet cable or IEEE 1394 cable, or use wireless LAN.

To connect using an IEEE 1394 cable, the IEEE 1394 interface board is required. To connect using wireless LAN, the IEEE 802.11b interface unit is required.

See *Network Guide*.



②

Make System Settings

Check the network settings in [**System Settings**], and change if required.

See *Network Guide*.



③

Install Software

On the client computers, install the software required for using the network TWAIN scanner functions, such as a TWAIN Driver and DeskTopBinder.

See p.10 "TWAIN Driver".

Scanning Originals

This section explains how to scan originals using the network TWAIN scanner function.

Note

- When using the TWAIN scanner, you can scan the original without entering a user code even if **[Weekly Timer Code]** has been selected in **[System Settings]**. See "System Settings", *General Settings Guide*.

1 Start **DeskTopBinder**, and then select the scanner driver.

1 On the **[Start]** menu, point to **[Program]**, point to **[DeskTopBinder V2]**, and then click **[DeskTopBinder V2]**.

2 On the **[Tools]** menu, click **[Scanner Settings...]**.

If the scanner is already selected, no scanner settings are necessary. Check the settings in **[File format for scanned image(s)]**, and then proceed to step **5**.

3 Click **[Select Scanner Driver...]**.

4 Select the name of the machine you want to use in the list, and then click **[Select]**.

Note

- If the machine you want to use is not displayed in the list, make sure that the IP address is configured and that the machine is correctly connected to the network. If the machine is still not displayed in the list after confirming the above, consult your network administrator.

5 Click **[OK]**.

2 Place originals.

Reference

The procedure for placing originals is the same as that for placing originals for copying. For details about placing originals, see "Placing Originals", *Copy Reference*.

3 Make the scan settings.

1 On the **[Tools]** menu, point to **[Add Document]**, and then click **[Scan...]**.

After a short while, the dialog box of the TWAIN Driver that operates the scanner appears. This dialog box is called the scanner properties dialog box.

Note

- The name of the scanner currently being used is shown on the title bar of the dialog box. When multiple machines are connected, make sure that the indicated machine is the machine you want to use. If it is different, click **[Select Scanner]** to select the scanner again.

2 Make settings according to such factors as the type of original, type of scanning, and orientation of the original.

Note

- For details about the settings, see the TWAIN Driver Help.

4 Click **[Scan]** in the scanner properties dialog box.

When there are additional originals to scan, place the originals, and then click **[Continue]**. When there are no more originals, click **[Complete]**.

 **Note**

- ❑ Depending on the security settings, a dialog box requesting your user name and password may appear when you press **[Scan]**.

5 Save the scan file in DeskTopBinder.

- ❶ On the **[File]** menu, click **[Exit]**.
- ❷ Enter the file name, and then click **[OK]**.

The image is stored in DeskTopBinder, and DeskTopBinder Viewer closes.

 **Editing and printing scan files**

With DeskTopBinder, it is possible to edit and print scan files. For details about how to edit and print, see DeskTopBinder Help.

7. Configuring/Registering Scan Settings

This section describes how to specify scan settings and how to configure settings according to the orientation of the original. In addition, this section describes the programming function by which you can register frequently used settings.

Specifying Scan Settings

1 Press [Scan Settings].

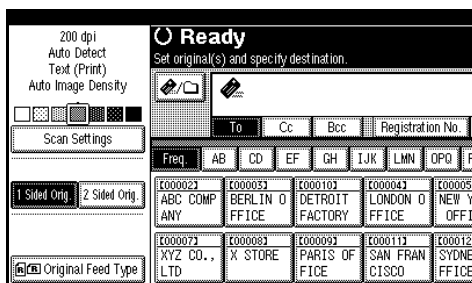

2 Select items such as resolution and original size, and then change their settings.

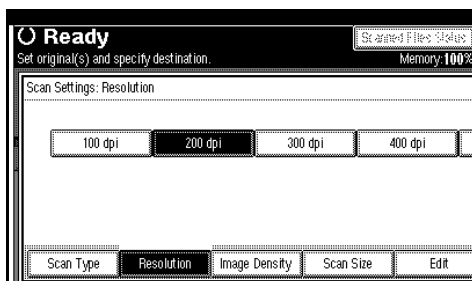

Specify the basic scan settings (scan type, resolution, image density, scan size, and edit) as follows:

❖ Scan Type

Originals are scanned according to the selected scan type. Select the scan type from the following:

- **Text (Print)**
For standard originals containing mainly text. Printer printing is best scanned with Text (Print).

- **Text (OCR)**

For standard originals containing mainly text. This setting increases character recognition accuracy. It is suitable for use when scanning and then using an optical character recognition (OCR) application.

- **Text / Photo**

For originals containing a mixture of text and photographs

- **Photo**

For originals containing photographs and other pictures (two-value).

Creates scanned images suitable for printing.

- **Gray Scale**

For originals containing photographs and other pictures (multi-value).

Creates scanned images suitable for displaying on a computer screen.

❖ Resolution

Select the resolution from 100 dpi, 200 dpi, 300 dpi, 400 dpi, or 600 dpi.

❖ Image Density

Select the image density in seven steps from **Lighter** (1) to **Darker** (7), or use Auto Image Density.

❖ Scan Size

Select the size of the original to be scanned.

When **[Auto Detect]** is selected, the auto detect function of the machine is used to set the original size.

When the size is specified, scanning is performed for that size, regardless of the actual size of the original. The following sizes can be selected:

A3☐, A4☐, A4☐, A5☐, A5☐, 11 × 17☐, 8¹/₂×14☐, 8¹/₂ ×13☐, 8¹/₂ × 11☐, 8¹/₂×11☐, 5¹/₂× 8¹/₂☐, 5¹/₂ × 8¹/₂☐, B4 JIS☐ (Japanese Industrial Standard), B5 JIS☐, B5 JIS☐, Custom Size

Note

- ☐ When **[Custom Size]** is selected, the dimensions of the scan area (width and height) can be specified.
- ☐ When selecting **[Custom Size]** for **[Scan Size]**, see p.107 “Scanning a custom-size original”.

❖ Edit

Make editing settings.

- Erase Border
Delete the borders of the scanned original according to the width specified.
If you select **[Same Width]**, you can specify, in millimeters, a uniform width for deleting all sides (top, bottom, left, and right). If you select **[Diff. Width]**, you can specify, in millimeters, a different width for deleting each side.

Note

- ☐ If you set **[Scan Size]** to **[Auto Detect]** and specify **[Mixed Sizes]**, one of the sides cannot be deleted.

3 Press **[OK]**.

Making the Settings Related to the Orientation of the Original and Scanned Sides

To correctly display the top/bottom orientation of a scanned original on a client computer, original orientation and page flow must be set when placing the original.

For E-mail, Scan to Folder, and a Network Delivery Scanner

- 1 Make settings for 1 Sided Original/2 Sided Original, Original Orientation, SADP/Batch, Mixed Sizes, and Divide, and Stamp.

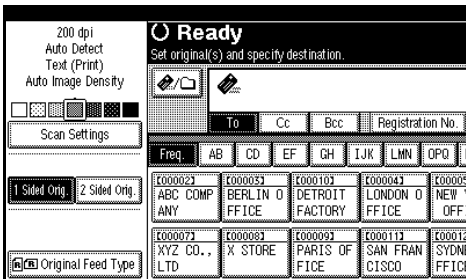

Note

- The defaults can be changed using [Original Setting], [Original Orientation Priority], [Switch to Batch], [Mixed Original Sizes Priority] of [Scanner Features]. See p.105 "Scan Settings".

One-sided original/Two-sided original selection

- 1 When scanning one-sided originals, make sure that [1 Sided Orig.] is selected.
- 2 When scanning two-sided originals, press [2 Sided Orig.] to select [2 Sided Orig.: T to T] or [2 Sided Orig.: T to B] according to the binding orientation of the original.

Top to top original:



Top to bottom original:

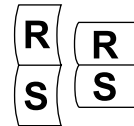

- 3 When the last page of two-sided originals is blank, select [1 Side] to skip that side and finish scanning, or select [2 Sides] to scan that side as a blank page.

Note

- When [1 Side] is selected for [Last Page], the file size will be bigger than a file resulting from individually scanning the same pages. If the size of the e-mail exceeds the limit specified, the e-mail cannot be sent. In this case, change the setting of [Max. E-mail Size] of [Scanner Features]. See p.110 "Send Settings".
- If you select [Divide], the setting made here is valid for the last page of the divided original.

- 4 Press [OK].

2 Make settings for original orientation, Batch/SADF, mixed original sizes, divide, and stamp by pressing [Original Feed Type].

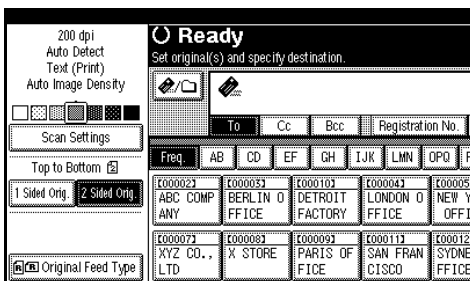

Orientation selection

- 1 Press the key for the same orientation as the actual orientation of the original, or .

Reference

For details about the orientation of the original and the orientation setting, see p.117 "Placing Originals".

Batch/SADF selection

- 1 When scanning a large number of originals by dividing the originals and scanning them individually or in batches, check that either [Batch] or [SADF] is selected.

Note

- Either [SADF] or [Batch] appears. If the mode you want to select does not appear, change the mode in [Switch to Batch] of [Scanner Features]. For details, see p.106 "Switch to Batch".

- To enable [Wait Time for Next Original(s): SADF] in [Scan Settings], select [SADF]. For details, see p.106 "Wait Time for Next Original(s): SADF".
- If you select [Batch], the machine waits for further originals, regardless of the system setting.

Mixed size selection

- 1 When originals of different sizes are placed, select [Mixed Sizes].

Note

- Originals of different sizes are scanned differently, depending on the settings and the positions of the originals. See. p.119 "Scanning Documents of Different Sizes".

Specifying Divide

- 1 If you want to divide and send a file containing multiple pages, press [Divide / Stamp], and then [Divide].
- 2 Press [Change], and then enter the number of divisions using the number keys.
- 3 Press the [#] key.
- 4 Press [Division Check] if necessary.

Note

- If you select [Division Check], a screen for stopping or continuing scanning appears if the originals are scanned out of order because of a paper jam or sheets feeding together.

- 5 Press [OK] twice.

Note

- If the final page of a divided original is blank, you can skip scanning that page. To do this, select [1 Side] in [Last Page] in [2 Sided Original]. To scan the blank page, click [2 Sides]. For details, see p.79 “One-sided original/Two-sided original selection”.

Specifying Stamping

- 1 To stamp scanned originals, press [Divide / Stamp], and then [Stamp].

Note

- Last pages are stamped even if you selected not to scan the last page.
- Stamping may continue if scanning is interrupted, depending on the cause of interruption.
- Replace the stamp cartridge when the stamp begins to fade. For details, see “Troubleshooting”, *General Settings Guide*.

- 2 Press [OK].

- 3 Press [OK].

Note

- The current settings are displayed.

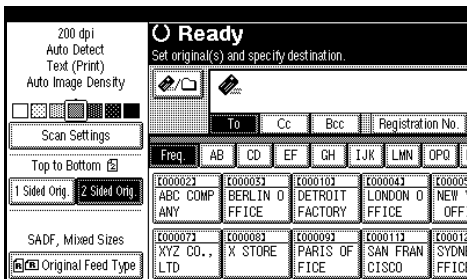

For a Network TWAIN Scanner

When using the network TWAIN scanner, make the setting using the TWAIN Driver.

- 1 Open the Scanner Properties dialog box.

Reference

p.74 “Scanning Originals”

- 2 Select the position from the [Original Scan Method:] list.

- 3 Select [Long Edge] or [Short Edge] from the [Orig.Orientn.:] list.

Reference

p.117 “Placing Originals”

- 4 In the [Orientation:] menu, select

[Right 90 deg.] or [Right 90 deg.],

[Left 90 deg.] or [Left 90 deg.],

[Standard 0 deg.] or [Standard 0 deg.], or

[180 deg.] or [180 deg.].

- 5 When the originals are placed in the ADF, select [1 Sided], [2 Sided(Top to Top)] or [2 Sided(Top to Bottom)] in the [Scan Settings:] list.

Note

- Originals of different sizes are scanned differently, depending on the settings. See. p.119 “Scanning Documents of Different Sizes”.

Scanning Originals in Several Times

Originals can be divided and scanned to form a single file using either the exposure glass or the ADF.

When originals are divided and scanned, the machine can wait two different ways for additional originals.

- Wait a specified length of time for the next original (Time limit set)
- Wait indefinitely for the next original (No time limit set)

When a Time Limit Is Specified for Additional Originals

In advance, specify the waiting time in seconds for placing the additional originals.

- Scanning using the exposure glass
Select **[Set Wait Time]** for **[Wait Time for Next Orig.: Exposure Glass]** of **[Scanner Features]**.
- Scanning using the ADF
Select **[Set Wait Time]** for **[Wait Time for Next Original(s): SADF]** in **[Scanner Features]**.

Reference

p.105 "Wait Time for Next Orig.: Exposure Glass" or "Wait Time for Next Original(s): SADF"

1 Place the originals.

Reference

The procedure for placing the originals is the same as that for placing the originals for copying. For details about placing the originals, see "Placing Originals", *Copy Reference*.

Note

- Originals are scanned in order. Place them from the first page.

2 Make settings for scanning area and original orientation.

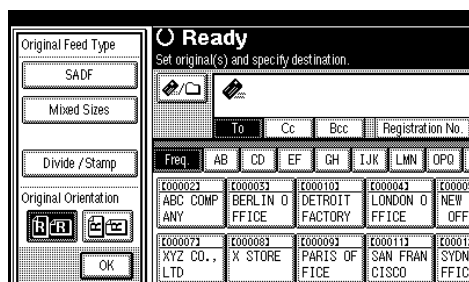

Reference

p.79 "Making the Settings Related to the Orientation of the Original and Scanned Sides"

3 Make settings for sending by e-mail, Scan to Folder, storing, or delivering.

Reference

p.17 "Procedure for Sending E-mail"

p.33 "Procedure for Sending by Scan to Folder"

p.48 "Storage Procedure"

p.64 "Delivery Procedure"

When using the exposure glass

1 Press the **[Start]** key.

When scanning is finished, the time remaining to place additional originals is displayed.

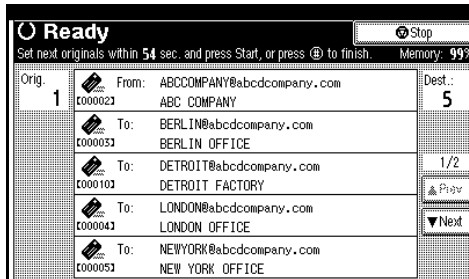

Note

- The selected destination appears while scanning the originals.

2 When there are additional originals, place them within the specified time, and then press the **[Start]** key.

Repeat this step until all originals are scanned.

Note

- If you change settings while the machine is waiting for additional originals, the countdown stops. Press the **[Start]** key to resume the countdown and scanning.

When using the ADF

1 Select **[SADF]** in **[Original Feed Type]**.

Note

- If **[SADF]** does not appear, select **[SADF]** in **[Switch to Batch]** of **[Scanner Features]**. See p.106 "Switch to Batch".

2 Press the **[Start]** key.

When scanning is finished, the time remaining to place additional originals is displayed.

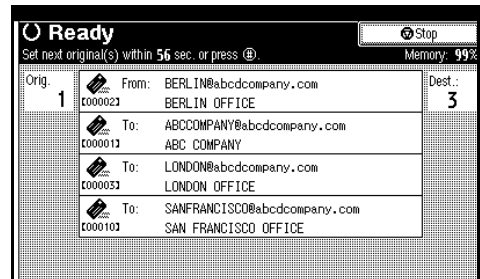

Note

- The selected destination appears while scanning the originals.

3 When there are additional originals, place them within the specified time.

The machine starts scanning automatically.

Note

- If you change settings while the machine is waiting for additional originals, the countdown stops. Press the **[Start]** key to resume the countdown and scanning.
- You can also use the exposure glass instead of the ADF. In this case, you must press the **[Start]** key to start scanning.

4 When all originals are scanned and the countdown is finished, the machine starts storing or sending automatically.

Note

- You can also press the **[#]** key to start storing or sending.

When a Time Limit Is Not Specified for Additional Originals

1 Place the originals.

Reference

The procedure for placing the originals is the same as that for placing the originals for copying. For details about placing the originals, see "Placing Originals", *Copy Reference*.

Note

- Originals are scanned in order. Place them from the first page.

2 Make settings such as original orientation and scanning area.

Reference

p.79 "Making the Settings Related to the Orientation of the Original and Scanned Sides"

3 Select [Batch] for [Original Feed Type].



Note

- If [Batch] does not appear, select [Batch] in [Switch to Batch] of [Scanner Features]. See p.106 "Switch to Batch".

4 Make settings for sending by e-mail, or Scan to Folder, storing, or delivering.

Reference

p.17 "Procedure for Sending E-mail"

p.33 "Procedure for Sending by Scan to Folder"

p.48 "Storage Procedure"

p.64 "Delivery Procedure"

5 Press the [Start] key.

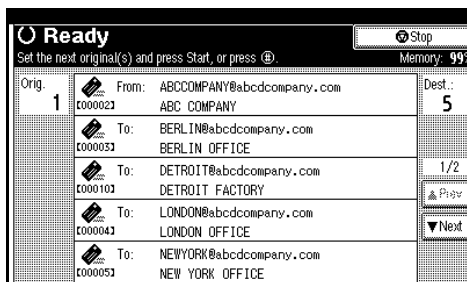

Note

- The selected destination appears while scanning the originals.

6 When there are additional originals to scan, place them and press the [Start] key.

Repeat this step until all originals are scanned.

7 After all originals are scanned, press the [#] key.

Storing or sending starts.

Programs

You can register frequently used settings in the machine memory and recall them for future use.

Note

- ❑ You can register up to 10 programs for the scanner mode.
- ❑ You can use the settings registered in program No.10 as the initial mode by selecting **[Program No.10]** in **[Change Initial Mode]** of **[Scanner Features]**.
- ❑ Programs are not deleted by turning the power off or by pressing the **[Clear Modes]** key. They are deleted only when you delete them or overwrite them with another program.
- ❑ The setting which can be registered in a program are as follows: the scan settings, 1 sided/2 sided original, Top to Top/Top to Bottom, Last Page, Divide, Original Feed Type, File Type, Batch/SADF, and Stamp.

Registering a Program

- 1** Make the settings you want to register in the initial display of the scanner mode.
- 2** Press the **[Program]** key.



AHV001S

- 3** Press **[⇨ Register]**.

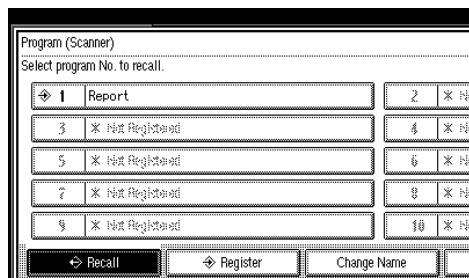

- 4** Press the program number you want to register.

Note

- ❑ Program numbers with **⇨** already have settings in them.

- 5** Enter the program name with the soft keyboard that appears on the display panel.

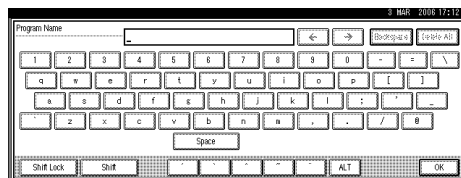

Note

- ❑ You can enter up to 40 characters.
- ❑ If it is not necessary to enter the program name, proceed to step **6**.

- 6** Press **[OK]**.

When the settings are successfully registered, **⇨** appears on the left side of the registered program number and the program name appears on the right side. The display returns to the initial display after a moment.

Recalling a Program

- 1** Make sure the [Scanner] key is selected, and then press the [Program] key.
- 2** Press [↔ Recall].

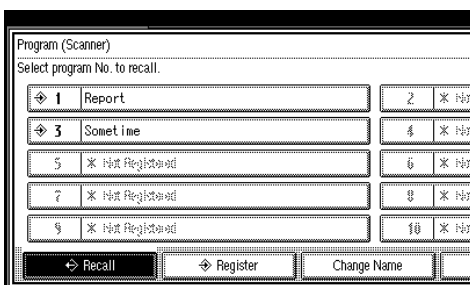

- 3** Press the number of the program you want to recall.

The registered settings are displayed.

Note

- Programs are not registered in numbers that appear without ↔.

- 4** Place the originals, and then press the [Start] key.

Changing a Registered Program

- 1** Make sure the [Scanner] key is selected, and then press the [Program] key.
- 2** Press [↔ Recall].
- 3** Press the number of the program you want to change.
- 4** Change settings of the program.
- 5** Press the [Program] key.
- 6** Press [↔ Register].

- 7** Press the number of the program for which you changed settings or the number of a different program in which you want to register the changed settings.

- 8** If you select a program that is already registered, a confirmation message appears. To overwrite the program, Press [Register].

Note

- If no program is registered under the number you select, skip to step 9.

- 9** Enter a program name.

- 10** Press [OK].

Note

- If you register a program in a number that is already registered, the old program is overwritten.

Deleting a Program

- 1** Make sure the [Scanner] key is selected, and then press the [Program] key.
- 2** Press [Delete].

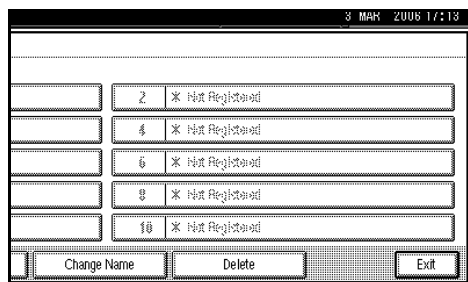

- 3** Press the number of the program you want to delete.

4 Press [Yes].

The program is deleted, and the display returns to the initial display after a moment.

Changing the Program Name

1 Make sure the [Scanner] key is selected, and then press the [Program] key.**2** Press [Change Name].

all.	
	2 * Not Registered
	4 * Not Registered
Not Registered	6 * Not Registered
Not Registered	8 * Not Registered
Not Registered	10 * Not Registered
<input type="button" value="Register"/> <input type="button" value="Change Name"/> <input type="button" value="Delete"/>	

3 Press the number of the program for which you want to change the name.**4** Enter a new program name.**Note**

- A program name can be entered using up to 40 characters.

5 Press [OK].

The new program name appears briefly, and then the display returns to the initial display.

8. Troubleshooting

This section contains advice on what to do if you have problems scanning an original, or if the network delivery scanner or e-mail function does not work. Various messages that may appear on the control panel or client computer are listed, along with causes and solutions.

If Your Machine Does Not Operate As You Want

When Scanning Is Not Performed as Expected

Problems	Causes and solutions
The scanned image is dirty.	The exposure glass or the exposure glass cover is dirty. Clean these parts. See <i>General Settings Guide</i> .
The image is distorted or out of position.	<ul style="list-style-type: none">• The original was moved during scanning. Do not move the original during scanning.• The original was not pressed flat against the exposure glass. Make sure that the original is pressed flat against the exposure glass.
The scanned image is upside down.	The original was placed upside down. Place the original in the correct orientation. See "Placing Originals", <i>Copy Reference</i> .
No image results from scanning.	The original was placed with the front and back reversed. When the original is placed directly on the exposure glass, the side to be scanned must face down. When the original is fed via the ADF, the side to be scanned must face up. See "Placing Originals", <i>Copy Reference</i> .
The scanned image contains white spaces.	<ul style="list-style-type: none">• If you scan originals using functions other than the network TWAIN scanner function, certain paper size and resolution settings may produce scanned images that are larger than the specified size because of margins being added to the sides. Scanning at a higher resolution may reduce the margins.• If the File Format Converter (optional) is installed, the margins may become wider.

When Stored Files Cannot Be Accessed

Problems	Causes and solutions
The stored file is locked and is not accessible.	The file, which is password protected, is locked because the password was incorrectly entered ten times. Consult the network administrator.

Network Cannot Be Browsed When Sending a Scan File

Problems	Causes and solutions
The network cannot be browsed when specifying the destination folder.	<p>The following machine settings may not be correct:</p> <ul style="list-style-type: none"> • IP address • subnet mask <p>Check the settings. See "Connecting and Setting Up", <i>Network Guide</i>.</p>

The TWAIN Driver Cannot Be Started

Problems	Causes and solutions
The Scanner Properties dialog box cannot be displayed.	Advanced encryption has been specified in the extended security setting. For details about the extended security setting, consult an administrator.

Stored Files Cannot Be Edited

Problems	Causes and solutions
Stored files cannot be deleted. File names and passwords cannot be changed. Files cannot be redelivered.	Limits have been imposed using the available extended security function. Consult the user administrator.

The Network Delivery Function Cannot Be Used

Problems	Causes and solutions
The network delivery function cannot be used.	<ul style="list-style-type: none"> • The network delivery function setting is not correct. Specify it correctly. For details, see "Connecting and Setting Up" "<i>Network Guide</i>". • The delivery software may be an old version or a security setting may be specified. Consult the machine administrator.

Operations are not possible when messages appear

Problems	Causes and solutions
"Updating the destination list... Please wait. Specified destination(s) or sender's name has been cleared." appears, and operations are not possible.	The destination list is being updated from the network using SmartDeviceMonitor for Admin. Depending on the number of destinations to be updated, there may be some delay before you can resume operation. Operations are not possible while this message is displayed. Wait until the message disappears. Do not switch off the power while this message is displayed.

When a Message Is Displayed

When an Error Message Appears on the Control Panel





 **Note**

- If an error message that is not included in this section appears, turn off the main power switch of the machine, and then turn it on again. If the message still appears, note the content of the message and the error number (if displayed), and contact your service representative. For information about how to turn off the main power switch, see *General Settings Guide*.

Message	Causes and solutions
Authentication has failed.	The entered login user name or login password is incorrect. Check the login user name and login password. The machine is unable to authenticate. Consult an administrator.
Authentication with the destination has failed. Check settings. To check the current status, press [Scanned Files Status].	<ul style="list-style-type: none"> • Check that the user name and password are correct. <p> Note</p> <ul style="list-style-type: none"> <input type="checkbox"/> A password of 64 or more characters may not be recognized. • Check that the ID and password for the destination folder are correct.
Cannot cancel sending certain file(s). To confirm the result, check [Scanned Files Status].	Only files in waiting can be canceled. Files with a delivery status of successful or other result cannot be canceled.
Cannot detect original size. Select scan size.	<ul style="list-style-type: none"> • Place the original correctly. • Specify the scan size. • When placing an original directly on the exposure glass, the lifting/lowering action of the ADF triggers the automatic original size detection process. Lift the ADF by more than 30 degrees. <p>See "Placing Originals", <i>Copy Reference</i>.</p>
Cannot find the specified path. Please check the settings.	Check whether the computer name and the folder name for the destination are correct.
Cannot log in with the entered user name or password.	Make settings correctly for the user name and password for authentication.

Message	Causes and solutions
Cannot send scanned data. Exceeded max. number of files. Unable to capture files.	For details about the maximum number of files that can be stored, see p.124 "Store". Reduce the number of stored files for transmission or delete unnecessary stored files.
Captured file exceeded max. number of pages per file. Cannot send the scanned data.	For details about the maximum number of pages per file that can be stored, see p.124 "Store". Reduce the number of pages in the file, and then resend it.
Connection with LDAP server has failed. Check the server status.	A network error has occurred and connection has failed. Try the operation once more. If the message is still shown, the network may be crowded. Check the information of System Settings. See "User Tools (System Settings)", <i>General Settings Guide</i> .
Connection with the destination has failed. Check the status and connection. To check the current status, press [Scanned Files Status].	<ul style="list-style-type: none"> • Check the network settings of the client computer. • Check that components such as the LAN cable are connected properly. • Check that the server settings are correct and the server is working properly.
Entered protection code for destination is incorrect. Please re-enter.	Make sure the protection code is correct, and then enter it again. See "Registering a Protection Code", "General Settings Guide."
Exceeded max. data capacity. Check the scanning resolution, then press Start again.	Specify the scan size and resolution again. Note that it may not be possible to scan very large originals at a high resolution. See p.113 "Relationship between Resolution and File Size".
<p>Exceeded max. data capacity. Check the scanning resolution, then reset nnn original(s).</p> <p> Note</p> <p><input type="checkbox"/> "nnn" in the message represents a changeable number.</p>	Specify the scan size and resolution again. Note that it may not be possible to scan very large originals at a high resolution. See p.113 "Relationship between Resolution and File Size".
Exceeded max. E-mail size. Sending E-mail has been cancelled. Check [Max. E-mail Size] in Scanner Features.	<ul style="list-style-type: none"> • Increase the size of [Max. E-mail Size]. • Set [Divide & Send E-mail] to [Yes (per page)] or [Yes (per max. size)]. See p.110 "Send Settings".

Message	Causes and solutions
Exceeded max. file capacity. Delete the unnecessary stored files.	For details about the maximum number of files that can be stored, see p.124 "Store". Reduce the number of stored files for transmission or delete unnecessary stored files.
<p>Exceeded max. No. of search results which can be displayed.</p> <p>Max. :nnn</p> <p> Note</p> <p><input type="checkbox"/> "nnn" in the message represents a changeable number.</p>	Search again after changing the search conditions.
Exceeded max. number of alphanumeric characters.	Make sure the maximum number of characters which can be entered, and then enter it again. See p.122 "Specifications for Transmission/Store/Delivery Functions".
Exceeded max. number of alphanumeric characters for the path.	The maximum number of characters which can be entered for the path is 128. Check the number of character you entered, and then enter the path again. See p.123 "Scan to Folder".
Exceeded max. number of files which can be sent at the same time. Reduce the number of the selected files.	The number of files exceeded the maximum number possible. Reduce the number of files and send them again.
Exceeded max. number of files which can be used in Document Server at the same time.	Check the files stored by the other functions, and then delete unneeded files. See "Document Server", <i>General Settings Guide</i> .
Exceeded max. number of pages per file. Do you want to store the scanned pages as 1 file?	Specify whether to use the data or not. Scan the pages that were not scanned and store them as a new file. See p.47 "Storing Files".
Exceeded max. number of standby files. Try again after the current file is sent.	There are 100 files waiting in the sending queue for e-mail, Scan to Folder, or delivery functions. Wait until files have been sent.
Exceeded max. page capacity per file. Press [Send] to send the scanned data, or press [Cancel] to delete.	Because the number of pages has reached the maximum number that can be sent, the data up to this point is sent. Scan the remaining pages after transmission.

Message	Causes and solutions
Exceeded time limit for LDAP server search. Check the server status.	A network error has occurred and connection has failed. Try the operation once more. If the message is still shown, the network may be crowded. Check the information of System Settings. See "User Tools (System Settings)", <i>General Settings Guide</i> .
LDAP server authentication has failed. Check the settings.	Make settings correctly for the user name and the password for LDAP server authentication.
Load paper of the following sizes. Required: A3  B4  A4  A4 	Load paper of the sizes listed in the message.
Memory is full. Cannot scan. The scanned data will be deleted.	Because of insufficient hard disk space, the first page could not be scanned. Try one of the following measures: <ul style="list-style-type: none"> • Wait for a while, and then retry the scan operation. • Reduce the scan area or scanning resolution. See p.101 "Scan Settings". • Delete unneeded stored files. See p.57 "Deleting Files".
Memory is full. Do you want to store scanned file?	Because there is not enough free hard disk space in the machine for storing in the Document Server, only some of the pages could be scanned. Specify whether to use the data or not.
Memory is full. Press [Send] to send the current scanned data, or press [Cancel] to delete.	Because there is not enough free hard disk space in the machine for delivering or sending by e-mail while storing in the Document Server, only some of the pages could be scanned. Specify whether to use the data or not.
Original is being scanned by another function.	The machine is using another function such as copying. Retry scanning after the operation with the other function is completed.
Output buffer is full. Sending the data has been cancelled. Please try again later.	Too many files are waiting to be delivered. Please try again after they have been delivered.
Selected file is currently in use. Cannot change file name.	You cannot change the name of a file whose status is "Waiting..." or that is being edited with DeskTopBinder. Change the file name after canceling delivery or completing editing.

Message	Causes and solutions
Selected file is currently in use. Cannot change password.	You cannot delete the password of a file whose status is "Waiting..." or that is being edited with DeskTop-Binder. Delete the password after canceling delivery or completing editing.
Selected file is currently in use. Cannot change user name.	You cannot change the user name for a file whose status is "Waiting..." or that is being edited with Desk-TopBinder. Change the user name after canceling delivery or completing editing.
Selected file is currently in use. Cannot delete it.	You cannot delete a file whose status is "Waiting..." or that is being edited with DeskTopBinder. Delete the file after canceling delivery or completing editing.
Sender's name is not selected. Please specify sender's name.	A sender's name should be specified before sending e-mail. Send e-mail after specifying the sender's name.
Sending the data has failed. The data will be resent later.	A network error has occurred and a file was not sent correctly. Wait until sending is retried automatically after the preset interval. If sending fails again, consult the network administrator.
Sending the data has failed. To confirm the result, check [Scanned Files Status].	While a file was being sent, a network error occurred and the file could not be sent correctly. Try the operation once more. If the message is still shown, the network may be crowded. Consult the network administrator. If multiple files were sent, use the Scanned Files Status screen to check for which file the problem occurred. See p.29 "Checking the E-mail Results", p.45 "Checking the Scan to Folder Results", or p.71 "Checking the Status of Delivery".
The destination list has been updated. Specified destination(s) or sender's name has been cleared.	A specified destination or sender's name was cleared when the destination list in the delivery server was updated. Specify the destination or sender's name again.
The E-mail address entered is not correct. Please re-enter.	Make sure the e-mail address is correct, and then enter it again.
The entered path is not correct. Please re-enter.	Confirm the destination computer and the path, and then enter it again.

Message	Causes and solutions
The selected file(s) which you do not have access privileges to could not be deleted.	You have tried to delete files without the authority to do so. The files can be deleted by the file administrator. To delete a file which you are not authorized to delete, contact the file administrator.
The specified group contains some invalid destination(s). Do you want to select only valid destination(s)?	The specified group contains some destinations for sending by e-mail and some destinations for sending by Scan to Folder. To select destinations for sending by email, press [Select] for the message displayed on the e-mail screen. To select destination for sending by Scan to Folder, press [Select] for the message displayed on the Scan to Folder screen.
Transmission has failed. Insufficient memory in the destination hard disk. To check the current status, press [Scanned Files Status].	Transmission has failed. There was not enough free space on the hard disk of the SMTP server, FTP server, or client computer at the destination. Allocate sufficient space.
Updating the destination list... Please wait. Specified destination(s) or sender's name has been cleared.	If a destination or sender's name was already selected, re-select it after this message disappears.
Updating the destination list has failed. Try again?	Check whether the server is connected.
You do not have the privileges to use this function.	The machine has not been set to allow you to use the function. Consult an administrator.

When an Error Message Appears on the Client Computer

This section describes the main possible causes and solutions for error messages displayed on the client computer when the TWAIN Driver is used.

 **Note**

- ❑ If an error message that is not included in this section appears, turn off the main power switch of the machine, and then turn it on again. If the message still appears, note the content of the message and the error number (if displayed), and contact your service representative. For information about how to turn off the main power switch, see *General Settings Guide*.

Message	Causes and solutions
[Cannot add any more scanning mode.]	The maximum number of modes that can be stored is 99. Delete unneeded modes.
[Cannot connect to the scanner. Check the network Access Mask settings in User Tools.]	The access mask is set. Consult the network or scanner administrator.
[Cannot detect the paper size of the original. Specify the scanning size.]	<ul style="list-style-type: none"> • Place the original correctly. • Specify the scan size. • When placing an original directly on the exposure glass, the lifting/lowering action of the ADF triggers the automatic original size detection process. Lift the ADF by more than 30 degrees.
[Cannot find the scanner. Check if the scanner main power is on.]	<ul style="list-style-type: none"> • Check whether the main power switch of the machine is turned off. • Check whether the machine is connected to the network correctly. • Deselect the personal firewall function of the client computer. • Use an application such as telnet to make sure SNMPv1 or SNMPv2 is set as the machine's protocol. For details, see <i>Network Guide</i>.
[Cannot find "XXX" scanner used for the previous scan. "YYY" will be used instead.]  Note ❑ "XXX" and "YYY" indicate scanner names.	<ul style="list-style-type: none"> • Check whether the main power switch of the scanner used for the previous scan is turned off. • Check whether the scanner used for the previous scan is connected to the network correctly. • Deactivate the personal firewall of the client computer. • Use an application such as telnet to make sure SNMPv1 or SNMPv2 is set as the machine's protocol. For details, see <i>Network Guide</i>. • Select the scanner used for the previous scan.

Message	Causes and solutions
[Cannot specify any more scanning area.]	The maximum number of scanning areas that can be stored is 99. Delete unneeded scanning area.
[Clear Misfeed(s) in ADF.]	Remove jammed originals, and place them again. Check whether the originals are suitable to be scanned by the machine.
[Communication error has occurred on the network.]	Check whether the client computer can use the TCP/IP protocol.
[Error has occurred in the scanner.]	Check whether the scanning settings made with the application exceed the setting range of the machine.
[Error has occurred in the scanner driver.]	<ul style="list-style-type: none"> • Check whether the network cable is connected correctly to the client computer. • Check whether the Ethernet board of the client computer is recognized correctly by Windows. • Check whether the client computer can use the TCP/IP protocol.
[Fatal error has occurred in the scanner.]	An unrecoverable error has occurred in the machine. Call your service representative.
[Insufficient memory. Close all other applications, then restart scanning.]	<ul style="list-style-type: none"> • Close all the unnecessary applications running on the client computer. • Uninstall the TWAIN Driver, restart the computer, and then reinstall the TWAIN Driver.
[Insufficient memory. Reduce the scanning area.]	<ul style="list-style-type: none"> • Reset the scan size. • Lower the resolution. • Set with no compression. See TWAIN Driver help. <p> Note</p> <ul style="list-style-type: none"> <input type="checkbox"/> “The Relationship between the Resolution and the Scanning Area” chart in Help for halftone scanning might not always apply. Scanning cannot be performed if large values are set for brightness when using halftone or high resolution. <input type="checkbox"/> When a paper misfeed occurs in the machine during printing, scanning cannot be performed. In this case, after the misfed paper has been removed, proceed with scanning.

Message	Causes and solutions
<p>[Invalid Winsock version. Please use version 1.1 or higher.]</p>	<p>Install the operating system of the computer or copy Winsock from the operating system CD-ROM.</p>
<p>[No response from the scanner.]</p>	<ul style="list-style-type: none"> • Check whether the machine is connected to the network correctly. • The network is crowded. Wait for a while, and then try to reconnect.
<p>[No User Code is registered. Consult your system administrator.]</p>	<p>Access is restricted with user codes. Consult the system administrator of the machine.</p>
<p>[Call Service Please call your service representative.]</p>	<p>An unrecoverable error has occurred in the machine. Call your service representative.</p>
<p>[Scanner is in use for other function. Please wait.]</p>	<p>A function of the machine other than the scanner function is being used such as the copier function. Wait for a while and reconnect.</p>
<p>[Scanner is not available. Check the scanner connection status.]</p>	<ul style="list-style-type: none"> • Check whether the main power switch of the machine is turned off. • Check whether the machine is connected to the network correctly. • Deselect the personal firewall function of the client computer. • Use an application such as telnet to make sure SNMPv1 or SNMPv2 is set as the machine's protocol. For details, see <i>Network Guide</i>.
<p>[Scanner is not available on the specified device.]</p>	<p>The TWAIN scanner function cannot be used on this machine. Contact your service representative.</p>
<p>[Scanner is not ready. Check the scanner and the options.]</p>	<p>Check whether the ADF cover is closed.</p>
<p>[The name is already in use. Check the registered names.]</p>	<p>You tried to register a name that is already in use. Use another name.</p>
<p>[Any of Login User Name, Login Password or Driver Encryption Key is incorrect.]</p>	<ul style="list-style-type: none"> • Check the login user name, login password, and driver encryption key. • Permission to use this function has not been granted. Contact the machine administrator.

9. Initial Scanner Setup

This section explains all required settings and procedures for using the machine as a network scanner.

Reference

First, see *General Settings Guide* to make basic settings, and then make scanner settings. For details about settings for e-mail, see "Connecting and Setting Up", *Network Guide*.

Scanner Features

The settings for using the network scanner functions of the machine are listed below. Make the necessary settings.

Note

Make settings for the items marked with ○ if necessary.

❖ Scan Settings

For explanations of settings, see p.105 "Scan Settings".

Settings		Default	E-mail	Scan to Folder	Store	Delivery	TWAIN
Default Scan Settings	Scan Type	Text (Print)	○	○	○	○	
	Resolution	200 dpi	○	○	○	○	
	Image Density	Auto Image Density (Medium)	○	○	○	○	
	Scan Size	Auto Detect	○	○	○	○	
Wait Time for Next Orig.: Exposure Glass		Set Wait Time (60)	○	○	○	○	
Wait Time for Next Original(s): SADF		Set Wait Time (60)	○	○	○	○	
Original Setting		1 Sided Original	○	○	○	○	
Switch to Batch		SADF	○	○	○	○	
Mixed Original Sizes Priority		Off	○	○	○	○	
Original Orientation Priority			○	○	○	○	
Change Initial Mode		Standard	○	○	○	○	

❖ **Destination List Settings**

For explanations of settings, see p.110 “Destination List Settings”.

Settings	Default	E-mail	Scan to Folder	Store	Delivery	TWAIN
Destination List Display Priority 1	Delivery Server	<input type="radio"/>	<input type="radio"/>		<input type="radio"/>	
Destination List Display Priority 2	E-mail Address	<input type="radio"/>	<input type="radio"/>			
Select Title	Title 1	<input type="radio"/>	<input type="radio"/>			
Update Delivery Server Destination List	-				<input type="radio"/>	

 **Note**

- If **[Off]** is selected for **[Delivery Option]** in **[File Transfer]** in **[System Settings]**, **[Destination List Display Priority 1]** and **[Update Delivery Server Destination List]** will not be displayed. For details see "Connecting and Setting Up", *Network Guide*.

❖ **Send Settings**

For explanations of settings, see p.110 “Send Settings”.

Settings	Default	E-mail	Scan to Folder	Store	Delivery	TWAIN
TWAIN Standby Time	On (10 sec.)	<input type="radio"/>	<input type="radio"/>	<input type="radio"/>	<input type="radio"/>	<input type="radio"/>
File Type Priority	Multi-page: TIFF	<input type="radio"/>	<input type="radio"/>			
Compression (Black & White)	On	<input type="radio"/>	<input type="radio"/>	<input type="radio"/>	<input type="radio"/>	
Compression (Gray Scale)	On(Compression Level 3)	<input type="radio"/>	<input type="radio"/>	<input type="radio"/>	<input type="radio"/>	
Print & Delete Scanner Journal	Print and Delete All	<input type="radio"/>	<input type="radio"/>		<input type="radio"/>	
Print Scanner Journal	-	<input type="radio"/>	<input type="radio"/>		<input type="radio"/>	
Delete Scanner Journal	-	<input type="radio"/>	<input type="radio"/>		<input type="radio"/>	
Max. E-mail Size	On (2048 KB)	<input type="radio"/>				
Divide & Send E-mail	Yes (per max. size) (Max. Number of Divisions 5)	<input type="radio"/>				
E-mail Information Language	British English	<input type="radio"/>				
Store File Priority	Off	<input type="radio"/>	<input type="radio"/>	<input type="radio"/>	<input type="radio"/>	
Stored File E-mail Method	Send File	<input type="radio"/>				

❖ Administrator Tools

For explanations of settings, see p.112 “Administrator Tools”.

Settings	Default	E-mail	Scan to Folder	Store	Delivery	TWAIN
Menu Protect	Level 2	-	-	-	-	-

Adjusting Scanner Features

In Scanner Features, you can make settings for basic operations when using this machine as a scanner. Normally, you can use the machine with its default settings. However, you can change the settings to suit your needs.

This section describes the Scanner Features settings. For details about the settings for the whole system, see *General Settings Guide*.

1 Press the **[User Tools/Counter]** key.

2 Press **[Scanner Features]**.

3 Press the item to be set.

4 Press the item to be set.

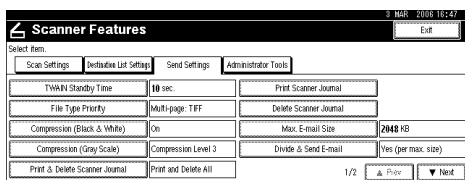

Example: **[TWAIN Standby Time]** setting of **[Send Settings]**

5 Change the setting.

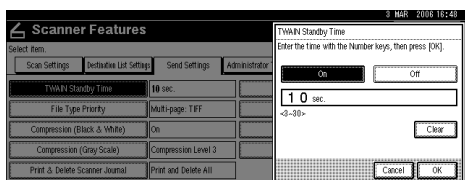

- To select an item, touch its key on the screen. The item is highlighted.
- To enter numbers, use the number keys.

Note

- To cancel changing a setting, press **[Cancel]**. The setting returns to the previous condition.

6 Press **[OK]**.

7 Repeat steps **3** to **6** to make the necessary settings, and then press **[Exit]**.

8 Press **[Exit]**.

The main menu reappears.

Settings

Scan Settings

This section explains how to set the defaults for scan settings.

The scan settings consist of the following. For the table about settings and defaults, see p.101 “Scanner Features”.

❖ Default Scan Settings

Various basic settings (scan type, resolution, image density, and scan size) can be set. You can register the scan settings in the same way as specifying them. For details, see p.77 “Specifying Scan Settings”.

- Scan Type
- Resolution
- Image Density
- Scan Size

❖ Wait Time for Next Orig.: Exposure Glass

When dividing originals and scanning them individually with the exposure glass to form a single file, select **[Off]**, **[Set Wait Time]**, or **[Continuous Wait]** for the waiting status.

Note

- If you select **[SADF]** in **[Original Feed Type]** on the Scan to Folder screen, the **[Wait Time for Next Orig.: Exposure Glass]** setting becomes invalid.
- If you select **[Batch]** in **[Original Feed Type]** on the Scan to Folder screen, the **[Wait Time for Next Orig.: Exposure Glass]** setting becomes invalid, and the machine waits for an additional original to be put in place. See p.80 “Batch/SADF selection”.

- If **[Set Wait Time]** is selected, enter the wait time in seconds (3-999) for placing additional originals with the number keys. Scanning will start if additional originals are placed and the **[Start]** key is pressed within this time. You can end scanning and begin transmission by pressing the **[#]** key within this time. Once the specified time has elapsed, transmission starts automatically.
- If **[Continuous Wait]** is selected, the machine will wait for additional originals until the **[#]** key is pressed. Scanning will start when additional originals are placed and the **[Start]** key is pressed. You can end scanning and begin sending by pressing the **[#]** key.
- If originals are placed in the automatic document feeder (ADF), transmission will start without waiting for additional originals after all originals in the ADF have been scanned, regardless of the specified settings.
- If a paper misfeed occurs or any of the following operations is performed while the machine is waiting for additional originals, the countdown stops and does not start again until the **[#]** key is pressed.
 - Changing the settings such as the scan settings
 - Opening the upper cover of the ADF
 - Pressing the **[Interrupt]** key to activate the copy mode

❖ Wait Time for Next Original(s): SADF

When dividing originals and scanning them separately with the ADF to form a single file, select **[Set Wait Time]** or **[Continuous Wait]** for the waiting status.

Note

- This setting is valid if **[SADF]** is specified for **[Original Feed Type]** when scanning. For details, see p.80 “Batch/SADF selection”.
- If **[Set Wait Time]** is selected, enter the wait time in seconds (3-999) for placing additional originals with the number keys. Scanning will start automatically if additional originals are placed within this time. You can end scanning and begin transmission by pressing the **[#]** key within this time. Once the specified time has elapsed, transmission starts automatically.
- If **[Continuous Wait]** is selected, the machine will wait for the additional originals until the **[#]** key is pressed. Scanning will start when additional originals are placed and the **[Start]** key is pressed. You can end scanning and begin sending by pressing the **[#]** key.
- Even if originals are placed on the exposure glass, the machine will operate according to the specified settings. However, every time originals are placed on the exposure glass, you must press the **[Start]** key to start scanning.
- If a paper misfeed occurs or any of the following operations is performed while the machine is waiting for additional originals, the countdown stops and does not start again until the **[#]** key is pressed.

- Changing the settings such as the scan settings
- Opening the upper cover of the ADF
- Pressing the **[Interrupt]** key to activate the copy mode

❖ Original Setting

Set the default for whether originals are one-sided or two-sided and if two-sided, the relationship between those sides. When the originals are always the same, set this for the default to make operation easier. You can select **[1 Sided Original]**, **[2 Sided Orig.: T to T]** (Top to Top), or **[2 Sided Orig.: T to B]** (Top to Bottom).

Reference

p.79 “Making the Settings Related to the Orientation of the Original and Scanned Sides”

❖ Switch to Batch

Select **[SADF]** or **[Batch]** as the scanning mode that appears as **[Original Feed Type]** in the initial display of the scanner mode.

Reference

p.82 “Scanning Originals in Several Times”

❖ Mixed Original Sizes Priority

This setting determines whether the original size is to be automatically detected when originals of different sizes are inserted in the ADF. You can select **[On]** or **[Off]**.

Note

- If the original size is specified when scanning, this setting is ignored.

- When **[Off]** is selected and **[Auto Detect]** is selected for scan size, if originals of different sizes are placed in the ADF, the maximum size will be detected as the scan size.

❖ Original Orientation Priority

Select the default for original placement orientation. When originals are always positioned the same way, select that orientation as the default to make operation easier.

🔍 Reference

p.79 “Making the Settings Related to the Orientation of the Original and Scanned Sides”

❖ Change Initial Mode

Select **[Standard]** to use the standard settings as the initial mode which is the mode of the machine immediately after the operation switch is turned on or modes are cleared or reset.

Select **[Program No.10]** to use the settings stored in Program No.10 as the initial mode.

Scanning a custom-size original

When scanning a custom-size original, measure the **[▶Original Size]**, **[▶Start Position]**, and **[▶Scan Area]** values, and specify the settings as described below. The procedure will be explained using the following original:

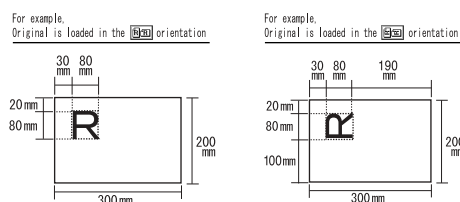

AHU006S

Procedure for Specifying a custom-size original

- 1** Press **[Custom Size]** on the Scan Size Setting screen.

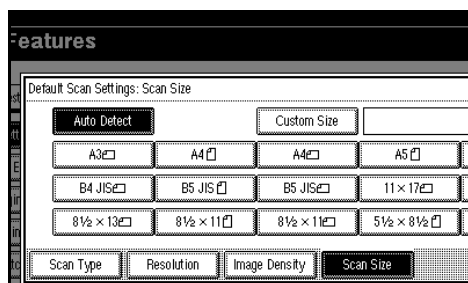

Scanning an entire original

The following diagrams explain the relationship between the **[▶Original Size]** (X1 and Y1) and **[▶Scan Area]** (X3 and Y3) settings.

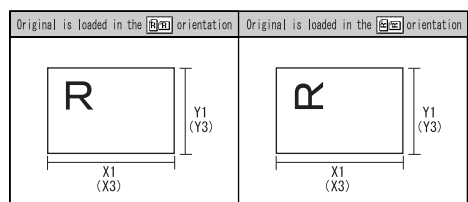

AHU007S

- 1** Specify **[▶Original Size]** (X1 and Y1) using the number keys, and then press the **[#]** key.

For example, set X1 to 300 mm and Y1 to 200 mm.

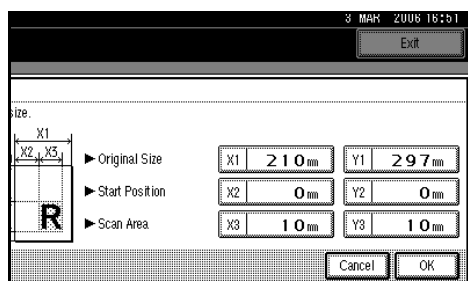

- Set [▶Start Position] (X2 and Y2) to 0 mm, and then press the [#] key.

Set X2 and Y2 to 0 mm.

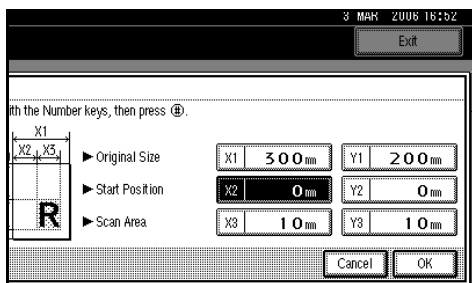

- Specify [▶Scan Area] (X3 and Y3) using the number keys, and then press the [#] key.

For example, set X3 to 300 mm and Y3 to 200 mm.

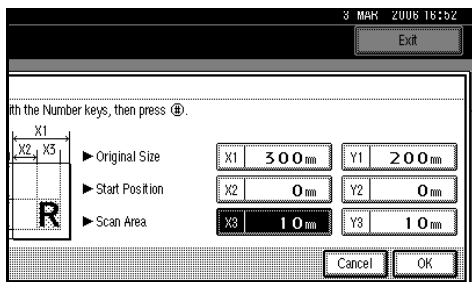

Scanning part of an original

The following diagrams explain the relationship between the [▶Original Size] (X1 and Y1), [▶Start Position] (X2 and Y2), and [▶Scan Area] (X3 and Y3) settings.

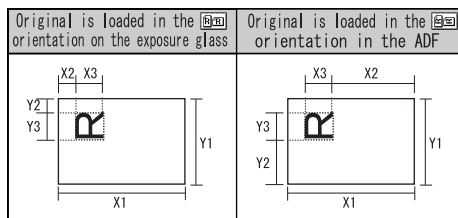
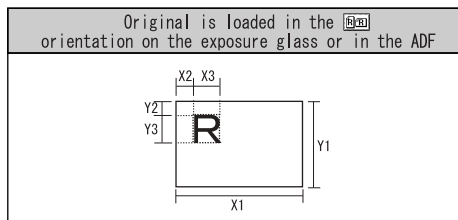

AHU008S

- Specify [▶Original Size] (X1 and Y1) using the number keys, and then press the [#] key.

For example, set X1 to 300 mm and Y1 to 200 mm.

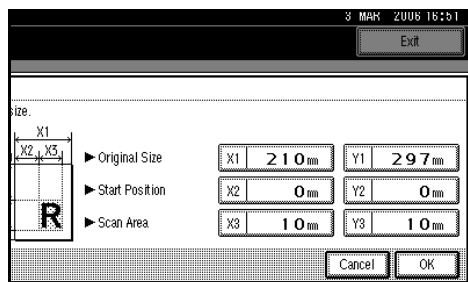

- 2** Specify [**▶Start Position**] (X2 and Y2) using the number keys, and then press the [**#**] key.

For example, set X2 to 30 mm and Y2 to 20 mm.

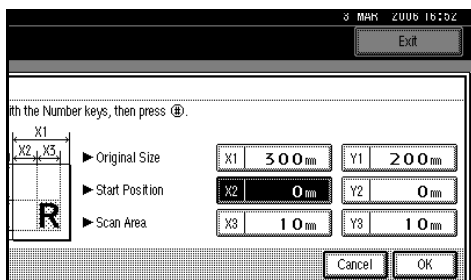

- 3** Specify [**▶Scan Area**] (X3 and Y3) using the number keys, and then press the [**#**] key.

For example, set X3 and Y3 to 80 mm.

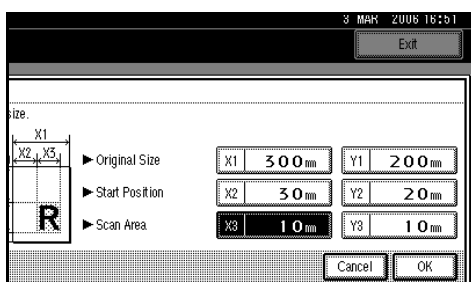

- 2** Press [**OK**].

- 3** Make sure the area specified in step **3** (X3 and Y3) is shown in the [**Custom Size**] field, and then press [**OK**].

- 4** Press [**Exit**] twice.

The main menu reappears.

Specifying and loading the original

- ❖ **Specifying the original's loading orientation**

Under [**Original Orientation**] select the original's loading orientation accordingly from [**Ⓡ**] or [**Ⓢ**]. [**Original Orientation**] appears if you press [**Original Feed Type**] on the scanner screen. See p.80 "Orientation selection".

- ❖ **Loading the original**

To load an original in the auto document feeder (ADF), place it top-first, face up. To load an original on the exposure glass, align it horizontally or vertically and then place it face down.

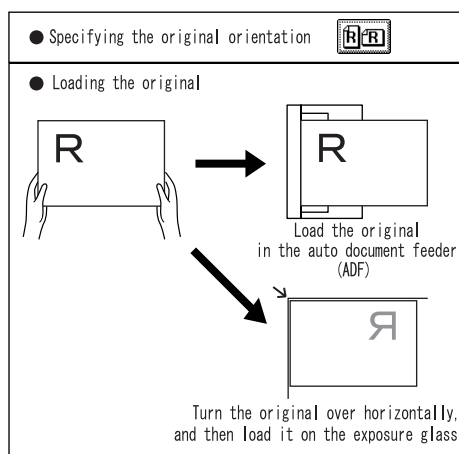

AHU009S

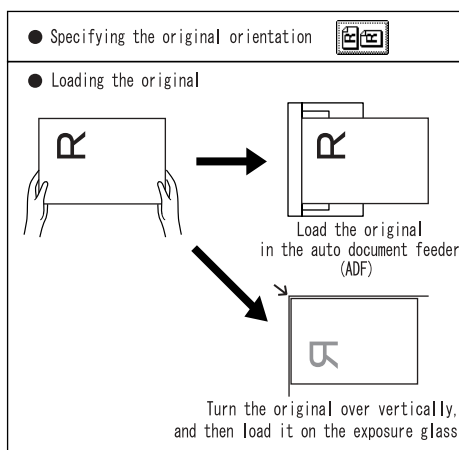

AHU010S

Destination List Settings

Select the defaults for the titles and the display priority for the destination list in the machine and the delivery server.

❖ Destination List Display Priority 1

Select a destination list to be displayed when the machine is in the initial state. You can select either **[E-mail / Folder]** or **[Delivery Server]**.

❖ Destination List Display Priority 2

In the machine's address book, select which address book appears by default.

You can select either **[E-mail Address]** or **[Folder]**.

❖ Select Title

Select the titles for destinations and group destinations of e-mail and Scan to Folder. Selected titles appear in the e-mail and Scan to Folder destination list to be used for searching for destinations. Select **[Title 1]** (ten titles), **[Title 2]** (ten titles), or **[Title 3]** (five titles).

❖ Update Delivery Server Destination List

To update the delivery server destination list, press **[Update Delivery Server Destination List]**.

Normally, the delivery server destination list is automatically updated. This function allows manual updating at any time.

Send Settings

This section explains how to set the defaults for settings such as the compression level for the scan file and switching to and from the network TWAIN scanner function.

The settings consist of the following. For the table about settings and defaults, see p.101 "Scanner Features".

❖ TWAIN Standby Time

When the machine is being used to send e-mail or a file, or functioning as Document Server or a network delivery scanner, a scanning request to the machine as a TWAIN scanner will switch the machine to the network TWAIN scanner function. This setting determines the delay until the machine switches to the network TWAIN scanner function.

- When **[Off]** is selected, the machine will switch to the network TWAIN scanner function at once.
- When **[On]** is selected, you can enter the delay time with the number keys (3-30 seconds). The machine will switch to the network TWAIN scanner function when the time set here passes after the last key operation.

❖ File Type Priority

Select whether to send the scanned originals as single-page files or a multiple-page file.

For single-page files, select either TIFF/JPEG or PDF. For multi-page files, select either TIFF or PDF.

Note

- You cannot select multi-page TIFF format for an image stored in JPEG format.

❖ **Compression (Black & White)**

Select whether or not to compress black and white scan files.

Note

- The actual time required for file transfer will vary depending on the file size and network load.
- Compression reduces the time required for transferring the scan file.

❖ **Compression (Gray Scale)**

Specify whether or not to compress multi-level (grayscale) scan files. Select **[On]** or **[Off]**.

Note

- If you select **[On]**, you can specify the compression level between one and five.
- The image quality is better for lower compression, but the time required for file transfer increases accordingly.
- The actual time required for file transfer will vary depending on the file size and network load.

❖ **Print & Delete Scanner Journal**

Up to 250 transmission/delivery results can be checked on this machine. If the stored transmission/delivery results reach 250, select whether to print the delivery journal.

- **[Print and Delete All]:**
The transmission/delivery journal is printed automatically. The printed journal is deleted.
- **[Do not Print: Delete Oldest]:**
Transmission/delivery results are deleted one by one as new results are stored.
- **[Do not Print: Disable Send]:**
Transmission/delivery cannot be performed when the journal is full.

Note

- When printed, all records are deleted after printing. When not printed, records over the limit are automatically deleted in succession from the oldest record.
- While the journal is being printed, files with the status waiting cannot be sent.

❖ **Print Scanner Journal**

The scanner journal is printed and deleted.

❖ **Delete Scanner Journal**

The scanner journal is deleted without being printed.

❖ **Max. E-mail Size**

Select whether or not to limit the size of an e-mail to which an image is attached.

When **[On]** is selected, enter the size limit (128-102400 KB) with the number keys.

Note

- When the SMTP limits the size, match that setting.

❖ **Divide & Send E-mail**

This function is effective only when **[On]** is selected for **[Max. E-mail Size]**.

Select whether or not an image exceeding the size specified in **[Max. E-mail Size]** should be divided and sent using more than one e-mail.

Select either **[No]**, **[Yes (per Page)]**, or **[Yes (per Max. Size)]**. When **[Yes (per Max. Size)]** is selected, enter the Max. Number of Divisions (2-500) with the number keys.

 **Note**

- When **[Multi-page: TIFF]** or **[Multi-page: PDF]** is selected for **[File Type Priority]**, the image will not be divided even if **[Yes (per Page)]** is selected.
- When **[Yes (per Max. Size)]** is selected, some received files may not be able to be restored, depending on the type of e-mail software.
- When **[No]** is selected, the e-mail is not sent if its size exceeds the limit, and an error message appears. The scan file is discarded.
- Set the maximum e-mail size within the capacity of the SMTP server.

❖ E-mail Information Language

Select the language in which e-mail information such as title, document name, and sender's name is sent.

Select one of the following 20 languages: British English, American English, German, French, Italian, Spanish, Dutch, Portuguese, Polish, Czech, Swedish, Finnish, Hungarian, Norwegian, Danish, Japanese, Simplified Chinese, Traditional Chinese, Russian, and Hangul.

 **Note**

- The e-mail text which is a template cannot be changed.

❖ Store File Priority

Select **[Send & Store]**, **[Store Only]**, or **[Off]** as the default that is displayed when modes are cleared or reset, or immediately after the operation switch is turned on.

 **Note**

- If you select **[Send & Store]**, "Send & Store" appears in **[Scanner Features]**, and files are stored and sent simultaneously.
- If you select **[Store Only]**, "Store Only" appears in **[Scanner Features]**, and files are only stored.
- If you select **[Off]**, **[Scanner Features]** shows that nothing has been selected. If you want to store files, specify **[Store File]** for scanning.

❖ Stored File E-mail Method

Specify the e-mail setting for sending stored files. You can select **[Send File]** or **[Send URL Link]**. This setting can be used for the following:

- Sending Stored Files by e-mail
- Simultaneous Storage and Sending by E-mail

 **Note**

- If you select **[Send File]**, actual files are attached to e-mails.
- If you select **[Send URL Link]**, URL Links to file locations are attached to e-mails.

Administrator Tools

❖ Menu Protect

You can prevent unauthenticated users from changing the user tools settings.

 **Note**

- For details, consult the administrator.

Relationship between Resolution and File Size

Resolution and scan area are inversely related. The higher the resolution is set, the smaller the area that can be scanned. Conversely, the larger the scan area, the lower the resolution that can be set.

The relationship between the scanning resolution and the file size is shown below. If the file size is too large, the message "Exceeded max. data capacity. Check the scanning resolution." appears on the control panel of the machine. Specify the scan size and resolution again.

📌 Limitation

- Depending on the image compression level, the maximum image size will be limited.

When Using for E-mail, Scan to Folder, or Store, or as a Network Delivery Scanner

❖ When Text, Text / Photo, or Photo is selected as the Scan Type

All combinations up to A3/297 × 432 mm (11 × 17 inches) and 600 dpi are possible.

❖ When Gray Scale is selected as the Scan Type

The originals can be scanned using combinations marked with ○ in the table.

	100 dpi	200 dpi	300 dpi	400 dpi	600 dpi
A3	○	○	○		
B4 JIS	○	○	○	○	
A4	○	○	○	○	
B5 JIS	○	○	○	○	
A5	○	○	○	○	○
B6 JIS ^{*1}	○	○	○	○	○
A6 ^{*1}	○	○	○	○	○
A7 ^{*1}	○	○	○	○	○
11 × 17	○	○	○		
Legal (8 ¹ / ₂ × 14)	○	○	○	○	
8 ¹ / ₂ × 13	○	○	○	○	
Letter (8 ¹ / ₂ × 11)	○	○	○	○	
5 ¹ / ₂ × 8 ¹ / ₂	○	○	○	○	○

^{*1} The scanning size must be manually entered.

When Using as a Network TWAIN Scanner

Reference

To specify the scanning area or resolution when using the machine as a network TWAIN scanner, see TWAIN Driver Help.

❖ When [Binary(Text)] or [Binary(Photo)] is selected for [Col./Grad.:]

The originals can be scanned using combinations marked with ○ in the table (Original orientation: .

	100 dpi	200 dpi	300 dpi	400 dpi	500 dpi	600 dpi	700 dpi	800 dpi	900 dpi	1000 dpi	1100 dpi	1200 dpi
A3	○	○	○	○	○	○						
B4 JIS	○	○	○	○	○	○						
A4	○	○	○	○	○	○	○	○				
B5 JIS	○	○	○	○	○	○	○	○	○			
A5	○	○	○	○	○	○	○	○	○	○	○	○
B6 JIS	○	○	○	○	○	○	○	○	○	○	○	○
A6	○	○	○	○	○	○	○	○	○	○	○	○
A7 * ¹	○	○	○	○	○	○	○	○	○	○	○	○
11×17	○	○	○	○	○	○						
Legal (8 ¹ / ₂ ×14)	○	○	○	○	○	○	○					
8 ¹ / ₂ ×13	○	○	○	○	○	○	○					
Letter (8 ¹ / ₂ ×11)	○	○	○	○	○	○	○	○				
5 ¹ / ₂ ×8 ¹ / ₂	○	○	○	○	○	○	○	○	○	○	○	○

*¹ The scanning size must be manually entered.

❖ When [Gray Scale] is selected for [Col./Grad.]:

The originals can be scanned using combinations marked with ○ in the table (Original orientation: ▭).

	100 dpi	200 dpi	300 dpi	400 dpi	500 dpi	600 dpi	700 dpi	800 dpi	900 dpi	1000 dpi	1100 dpi	1200 dpi
A3	○	○	○									
B4 JIS	○	○	○	○								
A4	○	○	○	○								
B5 JIS	○	○	○	○	○							
A5	○	○	○	○	○	○	○					
B6 JIS	○	○	○	○	○	○	○	○				
A6	○	○	○	○	○	○	○	○	○			
A7 *1	○	○	○	○	○	○	○	○	○	○	○	○
11×17	○	○	○									
Legal (8 ¹ / ₂ ×14)	○	○	○	○								
8 ¹ / ₂ ×13	○	○	○	○								
Letter (8 ¹ / ₂ ×11)	○	○	○	○	○							
5 ¹ / ₂ ×8 ¹ / ₂	○	○	○	○	○	○	○					

*1 The scanning size must be manually entered.

Relationship between File Type Specified for Scanning and File Type Specified for E-mail/File

The relationship between the file type specified when scanning originals and the file type converted into when sending e-mail or storing files is shown below by scan type.

File type specified Scan type	Single page		Multi page	
	TIFF/JPEG	PDF	TIFF	PDF
Text (Print)	TIFF	PDF	TIFF	PDF
Text (OCR)				
Text / Photo				
Photo				
Gray Scale	TIFF (Non-compression) / JPEG (Compression) *1		TIFF (Non-compression)	

*1 When Gray Scale is used, the file format is converted to JPEG when **[On]** is selected for **[Compression (Gray Scale)]** in **[Send Settings]**, and TIFF when **[Off]** is selected.

Note



- Files are stored in single-page style. When sending files by e-mail, you can select single-page style or multi-page style.
- You cannot select multi-page TIFF format for an image stored in JPEG format.









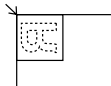
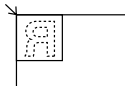

Placing Originals

To correctly display the top/bottom orientation of the scanned original on a client computer, the placement of the original and the settings made on the control panel and scanner driver must match.

There are two orientations for placing the original. See the table below.

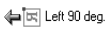
Note

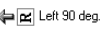
- Normally, an original is  or , but in the table below, a square original is used to make original orientation easy to understand. If the actual shape of the original is different, the combination of original orientation and the orientation specified on the control panel or scanner driver does not change.

1 An original to be scanned					
2 Decide the placement method.	Exposure glass		ADF		
3 Place the original. (There are two original orientations.)	Place the original so that the top edge touches the top left of the exposure glass. *1 	Place the original so that the top edge touches the rear of the exposure glass. 	Place the top edge of the original first. *1 	Place the original so that the top edge touches the back of the ADF. 	
4 Specify the orientation.	When scanning using the e-mail function, the Scan to Folder function, the Store function, or the delivery scanner function (Specified on the control panel screen)	Original Orientation 	Original Orientation 	Original Orientation 	Original Orientation 
	When scanning using the TWAIN scanner function (Specified in the Scanner Control dialog box)	 Left 90 deg.	 Standard 0 deg.	 Left 90 deg.	 Standard 0 deg.

<p>5 The original displayed on a computer</p>	
--	---

*1 When using the machine as a network TWAIN scanner, this is the standard orientation for the TWAIN Driver. Normally, set the original this way.

Scanning Documents of Different Sizes

The following table shows how originals of different sizes in a batch are scanned differently according to the setting and the position of the originals.

Settings	E-mail/Scan to Folder/Store/Network Delivery Scanner	TWAIN Scanner
[Mixed Sizes] is not specified. ([Scan Size] is set to [Auto Detect]) ^{*1}	<ul style="list-style-type: none"> Auto detection is used to determine the size of each original placed on the exposure glass. A whole batch of originals placed in the ADF will be scanned using the size of the maximum size original. 	A whole batch of originals is scanned using the size of the first original.
[Mixed Sizes] is specified. ([Scan Size] is set to [Auto Detect]) ^{*2}	Auto detection is used to determine the size of each original.	
[Scan Size] is specified.	When an original is smaller than the specified size, a blank space appears in the resulting image.	

^{*1} [Auto detect(Uni-size)] is selected under the TWAIN Driver.

^{*2} [Auto detect(Mixed-size)] is selected under the TWAIN Driver.

Reference

For details about the TWAIN Driver settings, see TWAIN Driver Help.

Software Supplied on CD-ROM

Table of files

CD-ROM	SETUP.exe Wizard for the TWAIN Driver and utilities		
	Drivers	Twain	TWAIN Driver for Windows 95/98/Me, Windows XP, Windows 2000, Windows NT 4.0, Windows Server 2003
	Utility	DeskV2	DeskTopBinder Lite

TWAIN Driver

This driver is required to scan an original on the machine.

To use the machine as a network TWAIN scanner, this driver must be installed.

❖ File storage folder

The files are stored in the following folder on the CD-ROM provided with this machine:

\DRIVERS\TWAIN

❖ System requirements

- Hardware
PC/AT-compatible machines that support the operating system properly

💡 Limitation

- Under Windows NT with RISC-based processors (MIPS R series, Alpha AXP, or PowerPC), this driver is not supported.
- Operating system
Microsoft Windows 95/98/Me
Microsoft Windows 2000/XP
Microsoft Windows NT 4.0
Microsoft Windows Server 2003
- Display resolution
800 × 600 pixels, 256 colours or higher

DeskTopBinder

DeskTopBinder is to be installed on the client computers for integration and management of various kinds of files such as scan files, files created with applications, and existing scan files. This software allows you to use various functions for stored scan files such as viewing stored files. Also, with the ScanRouter delivery software, you can view the files stored in in-trays of the delivery server or use other functions for stored files.

Reference

See DeskTopBinder Help or the manuals for DeskTopBinder.

❖ File storage folder

The files are stored in the following folder on the CD-ROM provided with this machine:

\UTILITY\DESKV2

❖ System requirements

- Hardware
PC/AT-compatible machines that support the operating system properly
- Operating system
Microsoft Windows 98SE/Me
Microsoft Windows 2000/XP
Microsoft Windows Server 2003
- Display resolution
800 × 600 pixels, 64K colours or higher

❖ Software installed with DeskTopBinder

- Auto Document Link
Auto Document Link on the client computer monitors in-trays of the delivery server. In addition, the files delivered to in-trays can be retrieved or notification of the arrival of a file can be received at the client computer with this software.
- Function Palette
Function Palette allows you to use functions such as the network TWAIN scanner, printing, printing preview, sending files by e-mail, or sending faxes without starting DeskTopBinder. You must make settings in advance in **[Extended Features...]** to use Function Palette. For details, see manuals related to DeskTopBinder.
- Extended Features Wizard
You can make the same settings in **[Extended Features...]** of the **[Tools]** menu with Extended Features Wizard. For details, see manuals related to DeskTopBinder.

Specifications for Transmission/Store/Delivery Functions

Note

- Depending on the type or settings of the file or document, you may not be able to specify the destination or enter the maximum number of characters stated below.

Transmission

E-mail

Maximum Number of Characters That Can Be Entered for E-mail	Title	128 ^{*1}
	Message	80
	E-mail Address	128 ^{*2}
Maximum Number of Destinations That Can Be Specified at Once	500 ^{*3} ^{*4}	
Maximum Number of Destinations That Can Be Registered in the Destination List	2000 ^{*5}	
Maximum Transmittable Sizes	Files	725.3 MB per file
	Pages	1000 per file

^{*1} This is the total number of characters entered directly and from subjects selected in the subject list.

^{*2} The e-mail address must meet the following requirements:

① The address must be specified using one of the following formats:

- name
- name@domain

② "name" and "domain" in ① must only consist of the following characters:

- numbers (0–9)
- letters (a-z, A-Z)
- symbols (! # \$ % & ' * + - / = ? ^ _ ` { | } ~)
- Period (.). They can be used anywhere except the beginning and end of an address or before @. Periods cannot be used next to each other.

^{*3} An e-mail address found using a LDAP server search cannot be specified properly if the address exceeds 128 characters.

^{*4} 100 destinations can be entered directly(including LDAP search).
The remaining 400 destinations can be selected from the registered addresses.

^{*5} This is the total number of e-mail destinations and file destinations.

Scan to Folder

Maximum Number of Characters That Can Be Entered for Scan to Folder	SMB	Destination folder path: 128 characters User name: 64 characters Password: 64 characters
	FTP	Server name: 64 characters Destination folder path: 128 characters User name: 64 characters Password: 64 characters
	NCP	Destination folder path: 128 characters User name: 64 characters Password: 64 characters
Maximum Number of Destinations That Can Be Specified at Once	50 ^{*1}	
Maximum Number of Destinations That Can Be Registered in the Destination List	2000 ^{*2}	
Maximum Transmittable Size	2000 MB per file	

^{*1} When directly entering the destinations, up to 50 destinations can be specified.

^{*2} This is the total number of e-mail destinations and file destinations.

Simultaneous Transmission

The following table shows the maximum number of destinations when performing E-mail and Scan to Folder simultaneously.

Transmission Type	Destination Selection Method	Selectable Number of Destinations	Selectable Number of Destinations for Each Function	Selectable Number of Destinations for E-mail and Scan to Folder
E-mail	Selected from the destination list	500	500	550
	Manual input (including LDAP search) ^{*1}	100		
Scan to Folder	Selected from the destination list	50	50	
	Manual input	50		

^{*1} An e-mail address found using a LDAP server search cannot be specified properly if the address exceeds 128 characters.

Store

Maximum Number of Characters That Can Be Entered for Stored File Information	File Name	64 ^{*1}
	User Name	20 ^{*1}
	Password	4-8 digit number
Maximum Number of Stored Files That Can Be Selected at Once	30	
Maximum number of files that can be stored	3000 ^{*2}	
Maximum number of pages that can be stored	9000 ^{*2}	
Maximum Number of Pages per file That Can Be Stored	1000	

^{*1} On the control panel, the first 16 characters are displayed. When viewing the stored files from a client computer using DeskTopBinder, all the entered characters can be viewed.

^{*2} This is the total number of files that can be stored under the scanner, copier, store, and printer functions.

The network delivery scanner function

Maximum number of characters that can be entered for delivery	Title	128 ^{*1}
	Delivery Destination (E-Mail Address)	128 ^{*2}
Maximum Number of Destinations That Can Be Specified at Once	500 ^{*3}	
Maximum Number of Destinations That Can Be Registered in the Destination List	See the manual provided with the ScanRouter delivery software.	

^{*1} This is the total number of characters entered directly and from subjects selected in the subject list.

^{*2} The e-mail address must meet the following requirements:

① The address must be specified using one of the following formats:























- name
- name@domain

② "name" and "domain" in ① must only consist of the following characters:

- numbers (1–9)
- letters (a-z, A-Z)
- symbols (! # \$ % & ' * + - / = ? ^ _ ` { | } ~)
- Period (.). They can be used anywhere except the beginning and end of an address or before @. Periods cannot be used next to each other.

^{*3} The maximum number of destinations that can be selected depends on the ScanRouter delivery software. For details, see the manual provided with the ScanRouter delivery software.

Specifications

Scan method	Flatbed scanning
Scan speed ^{*1}	E-mail/Scan to Folder/Network Delivery Scanner: 52 pages/minute (Scan size: A4  , Scan type: Text (Print), Resolution: 200 dpi, Compression (Black & White): On (MH), ITU-T No.1 chart, When scanning on one side)
Image sensor type	CCD Image Sensor
Scan type	Sheet, book
Interface	Ethernet interface (10BASE-T or 100BASE-TX), IEEE 1394 (IP over 1394) (optional), and IEEE 802.11b (Wireless LAN) (optional)
Maximum scan size	A3/297 × 432 mm, 11 × 17 inches
Sizes that can be detected automatically	<ul style="list-style-type: none"> Exposure glass A3 , B4 , A4  , B5   ADF A3 , B4 , A4  , B5  , A5  , B6  , 11" × 17"  , 8.5" × 13"  , 8.5" × 11"  
Resolution	600 dpi (8-bit grayscale)
Variable range of scan resolution	<ul style="list-style-type: none"> E-mail/Scan to Folder/Network Delivery Scanner Setting range: 100 dpi, 200 dpi, 300 dpi, 400 dpi, and 600 dpi TWAIN Scanner Setting range: 100 dpi - 1200 dpi
File formats that can be sent by e-mail	TIFF, JPEG, PDF
Compression method	Black & White: TIFF (MH, MR, MMR) Gray Scale: JPEG
Protocol	Network: TCP/IP, IPX Sending e-mail: SMTP Scan to Folder: SMB,FTP,NCP

^{*1} The scanning speed may differ according to the operating environment of the machine and the computer, and the contents of the original.

INDEX

A

Administrator Tools, 103, 112

B

Bindery, 38, 40

C

Checking the status of delivery, 71

[Check Modes] key, 3

[Clear Modes] key, 3

[Clear/Stop] key, 4

Compression (Black & White), 111

Compression (Gray Scale), 111

D

Default Scan Settings, 105

Delete Scanner Journal, 111

Delivering Scan File, 61

DeskTopBinder, 73, 121

Destination List Display Priority 1, 110

Destination List Display Priority 2, 110

Destination List Settings, 102, 110

Display panel, 3

Divide & Send E-mail, 111

E

Edit, 78

E-mail, 5, 15, 122

E-mail Information Language, 112

E-mail Screen, 16

[Energy Saver] key, 3

[#] Enter key, 4

F

File Type Priority, 110

FTP server, 6, 36

Function keys, 4

Function status indicators, 4

I

Indicators, 3

Installing software, 10

[Interrupt] key, 3

L

LDAP server, 5

Loading the original, 109

Login (Using the Control Panel), 12

Log Off (Using the Control Panel), 13

M

Main power indicator and power indicator, 3

Making the Settings Related to the Orientation of the Original and Scanned Sides, 79

Max. E-mail Size, 111

Menu Protect, 112

Mixed Original Sizes Priority, 106

N

NCP, 38, 40

NDS, 38, 40

NetWare, 38, 40

NetWare server, 6

Network Cannot Be Browsed
When Sending a Scan File, 90

Network delivery scanner, 8

Network Delivery Scanner Screen, 63

Network TWAIN scanner, 9, 73

Number keys, 4

O

Operations are not possible
when messages appear, 91

Operation switch, 4

Original Orientation Priority, 107

Original Settings, 106

P

Print & Delete Scanner Journal, 111

Print Scanner Journal, 111

[Program] key, 3

Programming E-mail Addresses and Folders, 14

Programs, 85

Q

Quick Install, 10

R

- Relationship between File Type Specified for Scanning and File Type Specified for E-mail/File, 116
- Relationship between resolution and file size, 113
- Resolution, 77

S

- Save, 75
- Scanning a custom-size original, 107
- Scanning originals, 74
- Scanning Originals in Several Times, 82
- Scan Settings, 101, 105
- Scan Size, 78
- Scan to Folder, 6, 31, 123
- Scan to Folder Screen, 32
- Scan Type, 77
- Select Title, 110
- Sending URL addresses of stored files by e-mail, 55
- Send Settings, 102, 110
- Simultaneously storing files
 - and sending their URL addresses, 28
- Simultaneous Storage and Delivery, 69
- Simultaneous Storage and Sending by E-mail, 27
- Simultaneous Storage and Sending by Scan to Folder, 43
- SMB, 35
- SMTP server, 5
- Software supplied on CD-ROM, 120
- Specifying the original's loading orientation, 109
- Stamp, 81
- [Start]** key, 4
- Store, 7, 47, 124
- Stored File E-mail Method, 112
- Store File Priority, 112
- Storing Files, 47
- Switch to Batch, 106

T

- The TWAIN Driver Cannot Be Started, 90
- Transmission, 122
- TWAIN Driver, 120
- TWAIN Standby Time, 110

U

- Update Delivery Server Destination List, 110
- User Authentication, 12
- User Code Authentication (Using the Control Panel), 12
- [User Tools/Counter]** key, 3

W

- Wait Time for Next Orig.
 - Exposure Glass*, 105
- Wait Time for Next Original(s)
 - SADF*, 106
- When a Time Limit Is Not Specified for Additional Originals, 84
- When a Time Limit Is Specified for Additional Originals, 82
- When Scanning Is Not Performed as Expected, 89
- When Stored Files Cannot Be Accessed, 89

In accordance with IEC 60417, this machine uses the following symbols for the main power switch:

I means POWER ON.

○ means POWER OFF.



Declaration of Conformity

“The Product complies with the requirements of the EMC Directive 89/336/EEC and its amending directives and the Low Voltage Directive 73/23/EEC and its amending directives.”

Trademarks

Adobe®, PostScript®, and Acrobat® are trademarks of Adobe Systems Incorporated.

Pentium® is a registered trademark of Intel Corporation.

NetWare® is a registered trademark of Novell, inc.

Microsoft®, Windows®, and Windows NT® are registered trademarks of Microsoft Corporation.

Other product names used herein are for identification purposes only and might be trademarks of their respective companies. We disclaim any and all rights to those marks.

- The product name of Windows® 95 is Microsoft® Windows® 95.
- The product name of Windows® 98 is Microsoft® Windows® 98.
- The product name of Windows® Me is Microsoft® Windows® Millennium Edition (Windows Me).
- The product names of Windows® 2000 are as follows:
Microsoft® Windows® 2000 Professional
Microsoft® Windows® 2000 Server
Microsoft® Windows® 2000 Advanced Server
- The product names of Windows® XP are as follows:
Microsoft® Windows® XP Home Edition
Microsoft® Windows® XP Professional
- The product names of Windows Server™ 2003 are as follows:
Microsoft® Windows Server™ 2003 Standard Edition
Microsoft® Windows Server™ 2003 Enterprise Edition
Microsoft® Windows Server™ 2003 Web Edition
- The product names of Windows NT® 4.0 are as follows:
Microsoft® Windows NT® Workstation 4.0
Microsoft® Windows NT® Server 4.0

Printer/Scanner Unit Type 3045 Operating Instructions Scanner Reference

